



PLASSON[®]
AUSTRALIA

PRODUCT CATALOGUE 2024

THE COMPLETE RANGE OF
FITTINGS FOR POLYETHYLENE
PIPING SYSTEMS.

GLOBAL PRESENCE - LOCAL COMMITMENTS

PLASSON's innovative products revolutionised the way of connecting polyethylene pipes in the 1960's. We started with fittings for agricultural irrigation and later developed solutions for urban water distribution.

Nowadays, water delivery systems in many of the world's great cities owe their excellence to PLASSON's innovative research and development.

PLASSON ensures superior designs and products, the widest range of fittings and adaptors and a genuine commitment to quality, delivery and service.

PLASSON continues to strive for the future environment. By using PLASSON products, you help us to invest in our vision of a world where clean, pure water will be everyone's birthright.



TABLE OF CONTENTS

RURAL COMPRESSION FITTINGS.....	2
THREADED FITTINGS.....	22
METRIC COMPRESSION FITTINGS.....	34
TAPPING SADDLES.....	80
VALVES.....	94
ELECTROFUSION FITTINGS.....	108
TOOLING.....	152
SIMONA SPIGOTS.....	172
INSTALLATION AND SPECIFICATIONS.....	208
TERMS AND CONDITIONS.....	216

HEAD OFFICE

Sydney
61 Dunning Avenue, Rosebery, NSW 2018

WAREHOUSES

Brisbane
49 Distribution Street, Larapinta, QLD 4110

Melbourne
25 Business Park Drive, Ravenhall, VIC 3023

Perth
8 Tacoma Circuit, Canning Vale, WA 6155

PLASSON AUSTRALIA

plasson.com.au
1300 752 776
sales@plasson.com.au

ABN 40 053 788 891









PLASSON

RURAL COMPRESSION FITTINGS





Rural Compression Fittings

7010	Page 8	Rural Coupling	
7010	Page 8	Rural Coupling Body	
7110	Page 9	Rural Reducing Coupling	
7020	Page 9	Rural Male Threaded Adaptor	
7250	Page 10	Union Adaptor With Male Thread	
7030	Page 10	Rural Female Adaptor	
7050	Page 11	90° Rural Elbow	
7850	Page 11	90° Rural Male Elbow	
7150	Page 12	90° Rural Female Elbow	

7040	Page 12	90° Rural Tee	
7340	Page 13	90° Rural Reducing Tee	
7840	Page 13	90° Rural Tee With Male Threaded Offtake	
7140	Page 14	90° Rural Tee With Female Threaded Offtake	
7140	Page 14	Reducing Tee Rural Female Threaded Offtake	
7120	Page 15	Rural End Plug	
7120	Page 15	Blanking Plug - Outlet Seal	
7940	Page 15	Modular Adaptor - For Close/Tight Assemblies	
1602	Page 16	Rural Tapping Saddle	

1607	Page 16	Tapping Saddle For Rural & Metric With S/S Reinforcing Ring	
7005	Page 17	Rural Adaptor	
7004	Page 17	Rural Nut	
7003	Page 17	Rural Split Rings	

Conversion Kits

7980	Page 18	Conversion Kit - Rural to Metric	
7980	Page 19	Conversion Kit - Metric to Rural	
7990	Page 19	Conversion Kit - Metric to Imperial 'C'	
7990	Page 19	Conversion Kit - Metric to Imperial 'D'	

PLASSON GOES ON & STAYS ON



CHOOSE PLASSON RURAL COMPRESSION FITTINGS FOR RELIABILITY AND PEACE-OF-MIND.

PLASSON rural compression fittings go on the pipe and seal watertight instantly. It isn't magic, just the result of some clever engineering.

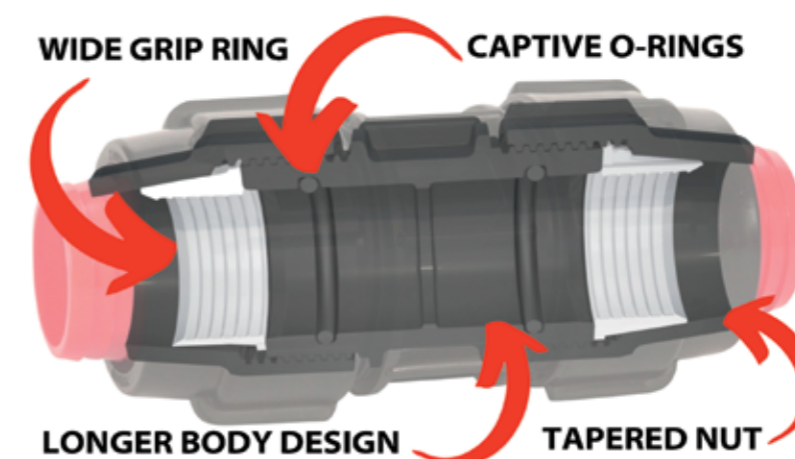

NO LEAKS
NO TOOLS
NO BLOW-OUTS
WITH PLASSON RURAL



INSTANT SEALING

PLASSON rural compression fittings go on the pipe and seal watertight instantly. Our captive o-ring creates a seal before you even tighten the nut. And you don't need any special tools to install our fittings. Just do the nuts up firmly by hand and the job is done.

FLEXIBLE

Our rural fittings can be converted to connect to metric poly (blue line), PVC, steel, and copper pipes.

LONG BODY

The long body on PLASSON fittings ensures the seal will not be affected by bending loads or ground movement.

PULL-OUT RESISTANT

All PLASSON fittings exceed the pull-out requirements of Australian Standards making PLASSON ideal for submersible bore jobs.

Rural Coupling

7010

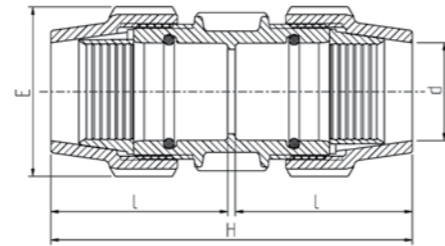

Product Code	Rural (d)	H	E	I	Bag	Carton	W
7010001	1/2"	105	39	50	10	400	52
7010002	3/4"	138	48	28	10	200	100
7010003	1"	144	54	30	10	160	130
7010004	1.1/4"	169	64	37	5	90	220
7010005	1.1/2"	214	82	50	1	55	380
7010006	2"	219	96	50	1	44	520

Rural Coupling Body

7010

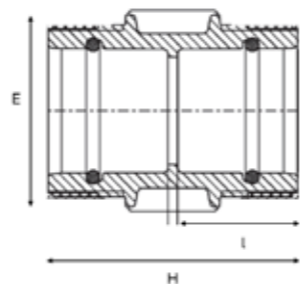

Product Code	Rural (d)	H	E	I	Bag
7010007	1/2"	138	48	28	1
7010008	3/4"	144	54	30	1
7010009	1"	169	64	37	1
7010010	1.1/4"	214	82	50	1
7010011	1.1/2"	219	96	50	1
7011012	2"	113	85	51	1

Suits rural and metric fittings.

Rural Reducing Coupling

7110

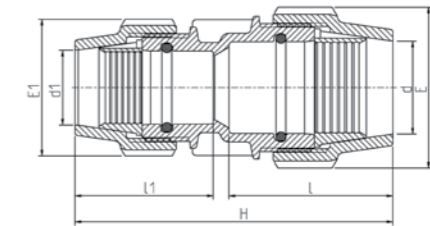

Product Code	Rural (d) x Rural (d1)	H	E	E1	I	I1	Bag	Carton	W
7110001	3/4" x 1/2"	151	48	39	28	50	10	200	70
7110002	1" x 1/2"	154	54	39	30	50	10	200	100
7110003	1" x 3/4"	136	54	48	30	28	10	180	120
7110004	1.1/4" x 3/4"	159	64	48	37	28	5	150	150
7110005	1.1/4" x 1"	164	64	54	37	30	5	120	170
7110006	1.1/2" x 1"	183	82	54	50	30	1	90	260
7110007	1.1/2" x 1.1/4"	186	82	64	50	37	1	70	300
7110008	2" x 1"	194	96	54	50	30	1	45	330
7110009	2" x 1.1/4"	197	96	64	50	37	1	50	380
7110010	2" x 1.1/2"	210	96	82	50	50	1	45	440

Rural Male Threaded Adaptor

7020

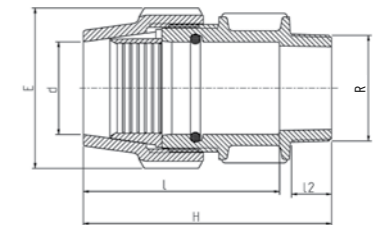

Product Code	Rural (d) x BSP (R)	H	E	I	I2	Bag	Carton	W
7020001	1/2" x 1/2"	79	39	59	16	10	500	34
7020002	1/2" x 3/4"	79	39	59	17	10	500	35
7020003	3/4" x 1/2"	99	48	28	17	10	340	60
7020004	3/4" x 3/4"	101	48	28	18	10	340	60
7020005	3/4" x 1"	101	48	28	20	10	340	60
7020006	1" x 1/2"	103	54	30	17	10	250	80
7020007	1" x 3/4"	103	54	30	18	10	250	80
7020008	1" x 1"	106	54	30	20	10	250	90
7020009	1.1/4" x 3/4"	117	64	37	18	5	150	130
7020010	1.1/4" x 1"	119	64	37	20	5	150	140
7020011	1.1/4" x 1.1/4"	121	64	37	22	5	150	140
7020012	1.1/4" x 1.1/2"	119	64	37	22	5	125	140
7020013	1.1/2" x 1"	136	82	50	20	1	100	220
7020014	1.1/2" x 1.1/4"	137	82	50	22	1	90	230
7020015	1.1/2" x 1.1/2"	138	82	50	22	1	90	220
7020016	1.1/2" x 2"	140	82	50	26	1	90	240
7020017	2" x 1"	142	96	50	20	1	70	310
7020018	2" x 1.1/4"	145	96	50	22	1	65	310
7020019	2" x 1.1/2"	145	96	50	22	1	60	300
7020020	2" x 2"	145	96	50	26	1	65	310

Union Adaptor with Male Thread

7250

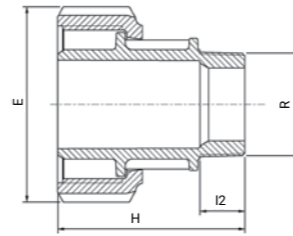

Product Code	Size d x R	E	H	I2	Bag	Carton	W
7250001	1 x 1/2"	54	79	17	1	200	36
7250002	1 x 3/4"	54	80	18	1	200	36
7250003	1.1/4" x 1/2"	64	85	17	1	180	66
7250004	1.1/4" x 3/4"	64	86	18	1	180	65
7250005	1.1/4" x 1"	64	87	20	1	180	68
7250006	1.1/2" x 1"	82	99	20	1	130	108
7250007	1.1/2" x 1 1/4"	82	100	22	1	130	112
7250008	1.1/2" x 1 1/2"	82	100	22	1	130	113
7250009	2" x 1"	96	102	20	1	80	147
7250010	2" x 1 1/4"	96	104	24	1	80	154
7250011	2" x 1 1/2"	96	104	24	1	80	156
7250012	2" x 2"	96	107	27	1	80	158

Rural Female Adaptor

7030

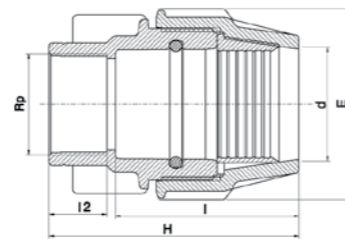

Product Code	Rural (d) x BSP (Rp)	H	E	I	I2	Bag	Carton	W
7030001	1/2" x 1/2"	73	39	52	19	10	500	36
7030002	1/2" x 3/4"	75	39	53	19	10	500	36
7030003	3/4" x 1/2"	90	48	28	19	10	350	60
7030004	3/4" x 3/4"	90	48	28	19	10	350	60
7030005	3/4" x 1"	90	48	28	21	10	300	70
7030006	1" x 3/4"	97	54	30	21	10	250	90
7030007	1" x 1"	97	54	30	21	10	250	80
7030008	1.1/4" x 3/4"	106	64	37	19	5	150	120
7030009	1.1/4" x 1"	101	64	37	21	5	150	130
7030010	1.1/4" x 1.1/4"	108	64	37	25	5	150	150
7030011	1.1/2" x 1"	132	82	50	21	1	100	210
7030012	1.1/2" x 1.1/4"	137	82	50	25	1	90	240
7030013	1.1/2" x 1.1/2"	137	82	50	25	1	70	250
7030014	2" x 1.1/4"	134	96	50	25	1	70	300
7030015	2" x 1.1/2"	134	96	50	25	1	60	310
7030016	2" x 2"	138	96	50	30	1	65	320

90° Rural Elbow

7050

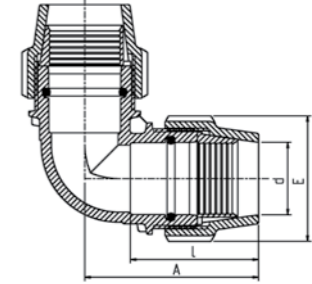

Product Code	Rural (d)	E	I	A	Bag	Carton	W
7050001	1/2"	39	50	63	10	350	57
7050002	3/4"	48	28	81	10	180	110
7050003	1"	54	30	88	10	150	140
7050004	1.1/4"	64	37	105	5	90	230
7050005	1.1/2"	82	50	137	1	50	400
7050006	2"	96	50	147	1	36	570

90° Rural Male Elbow

7850

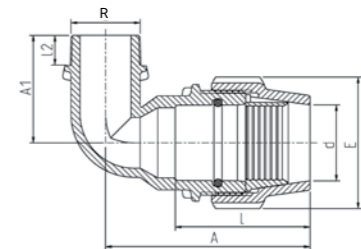

Product Code	Rural (d) x BSP (R)	E	I	A	A1	I2	Bag	Carton	W
7850001	3/4" x 1/2"	48	28	84	41	17	10	300	70
7850002	3/4" x 3/4"	48	28	84	43	18	10	300	70
7850003	1" x 1/2"	54	30	98	47	17	10	200	80
7850004	1" x 3/4"	54	30	98	48	18	10	200	90
7850005	1" x 1"	54	30	98	54	20	10	200	100
7850006	1.1/4" x 3/4"	64	37	116	55	18	5	100	140
7850007	1.1/4" x 1"	64	37	116	55	20	5	100	140
7850008	1.1/4" x 1.1/4"	64	37	116	58	22	5	100	150
7850009	1.1/2" x 1"	82	50	142	60	20	1	65	270
7850010	1.1/2" x 1.1/4"	82	50	142	66	22	1	70	240
7850011	1.1/2" x 1.1/2"	82	50	142	66	22	1	60	250
7850012	2" x 1"	96	50	153	71	20	1	50	320
7850013	2" x 1.1/4"	96	50	153	74	22	1	50	340
7850014	2" x 1.1/2"	96	50	153	74	22	1	50	350
7850015	2" x 2"	96	50	153	76	26	1	50	400

90° Rural Female Elbow

7150

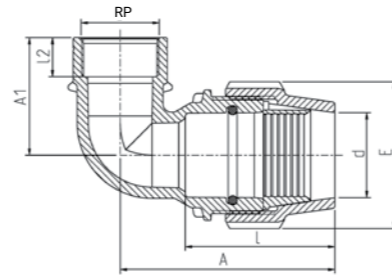

Product Code	Rural (d) x BSP (Rp)	E	I	A	A1	I2	Bag	Carton	W
7150001	1/2" x 1/2"	39	50	66	39	19	10	500	38
7150002	3/4" x 1/2"	48	28	86	40	19	10	300	60
7150003	3/4" x 3/4"	48	28	86	44	19	10	300	70
7150004	1" x 1/2"	54	30	90	46	18	10	200	60
7150005	1" x 3/4"	54	30	90	46	19	10	200	90
7150006	1" x 1"	54	30	90	50	21	10	200	100
7150007	1.1/4" x 3/4"	64	37	116	54	18	5	150	160
7150008	1.1/4" x 1"	64	37	116	54	21	5	150	150
7150009	1.1/4" x 1.1/4"	64	37	116	60	25	5	90	180
7150010	1.1/2" x 1"	82	50	142	52	21	1	70	230
7150011	1.1/2" x 1.1/4"	82	50	142	62	25	1	70	280
7150012	1.1/2" x 1.1/2"	82	50	142	62	25	1	60	290
7150013	1.1/2" x 2"	82	50	142	75	30	1	50	320
7150014	2" x 1"	96	50	153	57	21	1	50	310
7150015	2" x 1.1/4"	96	50	153	67	25	1	50	340
7150016	2" x 1.1/2"	96	50	153	66	25	1	50	370
7150017	2" x 2"	96	50	153	85	30	1	45	410

90° Rural Tee

7040

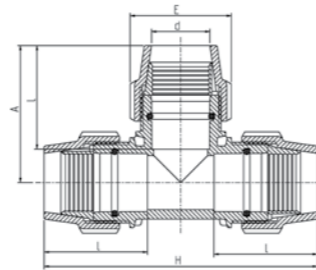

Product Code	Rural (d)	H	E	I	A	Bag	Carton	W
7040001	1/2"	126	39	50	63	10	220	83
7040002	3/4"	162	48	28	81	10	120	160
7040003	1"	174	54	30	87	5	80	210
7040004	1.1/4"	209	64	37	105	5	55	340
7040005	1.1/2"	258	82	50	129	1	30	590
7040006	2"	270	96	50	135	1	20	830

90° Rural Reducing Tee

7340

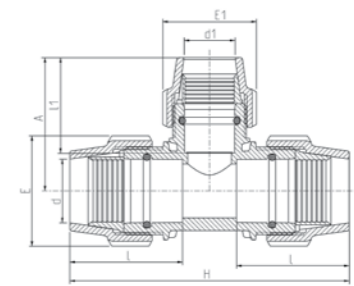

Product Code	Rural (d) x Rural (d1)	H	E	E1	I	I1	A	Bag	Carton	W
7340001	3/4" x 1/2"	162	48	39	28	50	30	10	150	130
7340002	1" x 3/4"	168	54	48	30	28	84	5	100	200
7340003	1.1/4" x 1"	209	64	54	37	30	105	5	60	300
7340004	1.1/2" x 1"	242	82	54	50	30	127	1	40	480
7340005	1.1/2" x 1.1/4"	242	82	64	50	37	127	1	38	520
7340006	2" x 1"	246	96	54	50	30	134	1	24	620
7340007	2" x 1.1/4"	246	96	64	50	37	134	1	24	670
7340008	2" x 1.1/2"	246	96	82	50	50	134	1	24	750

90° Rural Tee With Male Threaded Offtake

7840

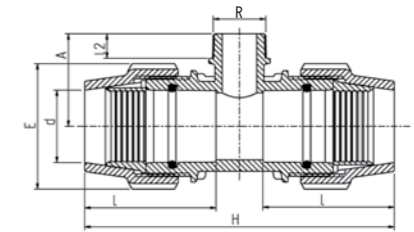

Product Code	Rural (d) x BSP (R)	H	E	I	A	I2	Bag	Carton	W
7840001	3/4" x 1/2"	154	48	28	46	17	10	180	110
7840002	3/4" x 3/4"	160	48	28	46	18	10	180	120
7840003	1" x 1/2"	178	54	37	48	17	5	120	140
7840004	1" x 3/4"	164	54	30	50	18	5	120	140
7840005	1.1/4" x 1"	194	64	37	58	20	5	80	240
7840006	1.1/2" x 1.1/4"	242	82	50	71	22	1	40	430
7840007	1.1/2" x 1.1/2"	242	82	50	71	22	1	40	430
7840023	2" x 1.1/4"	248	96	50	77	22	1	30	610
7840008	2" x 1.1/2"	248	96	50	77	22	1	30	580
7840009	2" x 2"	248	96	50	82	26	1	30	600

90° Rural Tee With Female Threaded Offtake

7140

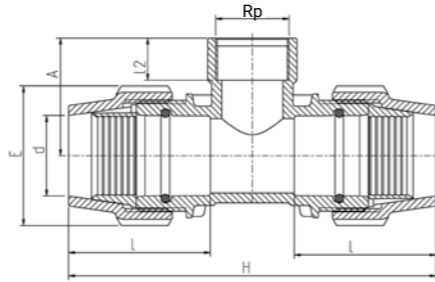

Product Code	Rural (d) x BSP (Rp)	H	E	I	A	I2	Bag	Carton	W
7140001	1/2" x 1/2"	122	39	50	42	17	10	240	66
7140002	1/2" x 3/4"	122	39	50	41	19	10	240	65
7140004	3/4" x 1/2"	160	48	28	42	18	10	200	110
7140005	3/4" x 3/4"	160	48	28	45	19	10	180	110
7140006	1" x 1/2"	169	54	30	45	18	5	120	150
7140007	1" x 3/4"	169	54	30	48	19	5	120	160
7140008	1" x 1"	176	54	30	53	21	5	80	160
7140009	1" x 1.1/4"	176	54	30	64	25	5	80	210
7140011	1.1/4" x 3/4"	201	64	37	51	19	5	80	240
7140012	1.1/4" x 1"	201	64	37	54	21	5	80	240
7140013	1.1/4" x 1.1/4"	207	64	37	65	25	5	60	280
7140014	1.1/4" x 1.1/2"	207	64	37	71	25	5	60	300
7140015	1.1/2" x 1"	240	82	50	61	21	1	44	420
7140016	1.1/2" x 1.1/4"	254	82	50	70	24	1	40	460
7140017	1.1/2" x 1.1/2"	254	82	50	70	25	1	40	470
7140018	1.1/2" x 2"	254	82	50	78	30	1	32	490
7140019	2" x 1.1/2"	262	96	50	76	25	1	28	640
7140020	2" x 2"	262	96	50	80	30	1	24	660

Reducing Tee Rural Female Threaded Offtake

7140

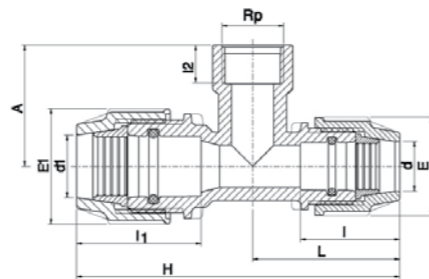

Product Code	Rural (d) x BSP (Rp) x Rural (d1)	H	E	I	A	I2	Bag	Carton	W
7140003	3/4" x 3/4" x 1/2"	160	48	28	42	18	10	200	0,09
7140010	1.1/4" x 1" x 1"	201	64	37	54	21	5	80	0,196

Rural End Plug

7120

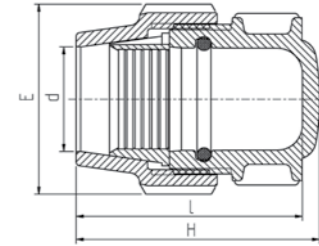

Product Code	Rural (d)	H	E	I	Bag	Carton	W
7120001	1"	90	54	30	10	200	80
7120002	1.1/4"	100	64	37	5	180	130
7120003	1.1/2"	120	82	50	1	100	220
7120004	2"	130	96	50	1	70	300

Blanking Plug - Outlet Seal

7120

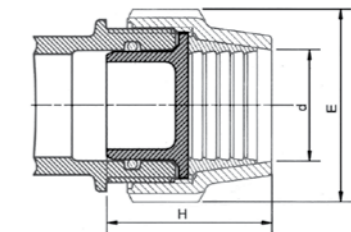

Product Code	Rural	E	H	Bag	Carton	W
7120005	3/4"	48	47	10	2500	5
7120006	1"	54	51	10	1500	8
7120007	1 1/4"	64	56	10	1000	15
7120008	1 1/2"	82	66	10	720	24
7120009	2"	96	80	10	400	41

Use to seal any metric or rural compression fittings.
12.5 Bar pressure capacity.

Modular Adaptor - For Close/Tight Assemblies

7940

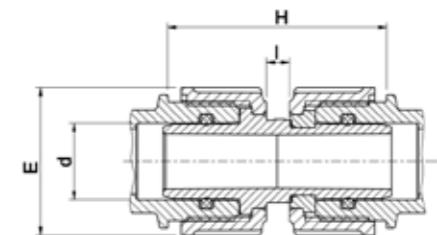

Product Code	Rural	E	H	I	Bag	Carton	W
7940001	3/4"	48	80	10	10	300	50
7940002	1"	54	80	10	10	250	61
7940003	1.1/4"	64	93	10	5	180	104
7940004	1.1/2"	82	102	10	5	100	173
7940005	2"	93	107	10	1	70	257

Rural Tapping Saddle

1602

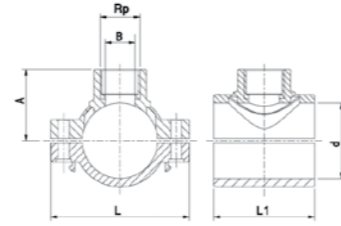

For measurements see tapping saddle section.

Galvanised Bolts	Stainless Steel Bolts	Rural (R) x BSP (Rp)	Bolts
Product Code	Product Code		
1607010	1607118	2" x 1/2"	2
1602001	1602003	2" x 3/4"	2
1602002	1602004	2" x 1"	2

Bolts galvanised via electroplating then protected with a proprietary passivation process.

Tapping Saddle For Rural & Metric With S/S Reinforcing Ring

1607

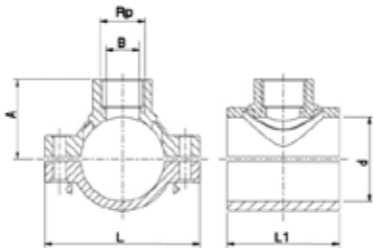

For measurements see tapping saddle section.

Galvanised Bolts	Stainless Steel Bolts	Metric (Rural) (d) x BSP (Rp)	Bolts
Product Code	Product Code		
1607001	1607109	20 (3/4") x 1/2"	Metric & Rural (Long Bolts)
1607002	1607110	25 (1") x 1/2"	Metric & Rural (Long Bolts)
1607003	1607111	25 (1") x 3/4"	Metric & Rural (Long Bolts)
1607004	1607112	32 (1.1/4") x 1/2"	Metric & Rural (Long Bolts)
1607005	1607113	32 (1.1/4") x 3/4"	Metric & Rural (Long Bolts)
1607006	1607114	32 (1.1/4") x 1"	Metric & Rural (Long Bolts)
1607007	1607115	40 (1.1/2") x 1/2"	Metric & Rural (Long Bolts)
1607008	1607116	40 (1.1/2") x 3/4"	Metric & Rural (Long Bolts)
1607009	1607117	40 (1.1/2") x 1"	Metric & Rural (Long Bolts)
1607011	1607119	50 (2") x 1.1/4"	Metric & Rural (Long Bolts)

Rural Adaptor

7005



Product Code	Rural	Bag
7005001	3/4"	10
7005002	1"	10
7005003	1.1/4"	5
7005004	1.1/2"	5
7005005	2"	5

Rural Nut

7004



Product Code	Rural	Bag
7004018	3/4"	1
7004019	1"	1
7004020	1.1/4"	1
7004021	1.1/2"	1
7004022	2"	1

Rural Split Rings

7003



Product Code	Rural	Bag
7003026	3/4"	1
7003025	1"	1
7003001	1.1/4"	1
7003002	1.1/2"	1
7003003	2"	1

CONVERSION KITS

Discover Even More Ways to Connect

PLASSON understands not everything lines up perfectly in the real world. That is why our range includes Conversion Kits. These kits contain helpful adaptors that allow you to easily switch between metric, rural, copper, PVC pipe and threads.

The body design of all PLASSON compression fittings is the same so it is easy to adapt fittings to several different pipe materials, sizes and threaded connections. PLASSON has engineered this flexibility into the range to provide a solution for almost any situation without the need for lots of specialised fittings.

FEATURES:

- ✓ Easily joins different pipe materials
- ✓ Reliably connects different pipe sizes
- ✓ More off-the-shelf solutions from fewer fittings

Conversion Kit - Rural to Metric

7980



Product Code	Rural x Metric	Bag
7980001	3/4" x 20	1
7980002	1" x 25	1
7980003	1.1/4" x 32	1
7980004	1.1/2" x 40	1
7980005	2" x 50	1

Rural Conversion Kit - Metric to Rural

7980



Product Code	Metric x Rural	Bag
7980006	20 x 3/4"	1
7980007	1" x 25	1
7980008	1.1/4" x 32	1
7980009	1.1/2" x 40	1
7980010	2" x 50	1

Rural Conversion Kit - Metric to Imperial 'C'

7990



Product Code	Metric x Imperial 'C'	Bag
7990001	32 x 1"	1
7990002	40 x 1.1/4"	1
7990003	50 x 1.1/2"	1

Rural Conversion Kit - Metric to Imperial 'D'

7990



Product Code	Metric x Imperial 'D'	Bag
7990004	25 x 3/4"	1
7990005	32 x 1"	1

ARE YOU SICK OF CANE TOADS?

Break the breeding cycle and trap hundreds of tadpoles at a time!



Be part of the solution!

Humane, effective cane toad control is here! PLASSON and Watergum have partnered to bring you the Cane Toad Tadpole Trap + Lure system which allows you to remove hundreds of cane toad tadpoles at a time, before they grow up and cause damage to our environment, pets and agriculture.

Once you spot tadpoles, set your trap and let nature do the work. Ideal for use in private waterways like dams, streams and ponds.



Screw lid on and set in calm shallow water



Secure in place, add lure and leave for 4 hours



Remove, drain, dispose of tadpoles, clean and reset



Find your local stockist:
watergum.org/store-locator/

Watch the instructional video

<https://qrco.de/bd9R7N>



Cane Toad Traps

7990



Product Code	Description	L	H	W
9000001	Tadpole Trap incl. Bucket and Lid	130mm	115mm	634g

Cane Toad Lures

7990



Product Code	Description
9000002	Tadpole Lures (Pack of 5)

watergum
community for environment





1300 752 776 | plasson.com.au









 PLASSON

THREADED FITTINGS



Threaded Fittings

5040		
Page 26	90° Threaded Tee	
5041		
Page 26	90° Threaded Tee with S/S Reinforced Ring	
5050		
Page 27	90° Threaded Elbow	
5051		
Page 27	90° Threaded Elbow with S/S Reinforcing Ring	
5150		
Page 27	90° Threaded Elbow Male x Female	
5060		
Page 28	Threaded Nipple	
5060		
Page 28	Threaded Reducing Nipple	
5170		
Page 29	Threaded Plug	
5070		
Page 29	Threaded Cap	

5010		
Page 30	Threaded Socket	
5011		
Page 30	Threaded Socket with S/S Reinforcing Ring	
5110		
Page 30	Threaded Reducing Socket	
5160		
Page 31	Threaded Riser	
5020		
Page 31	Threaded Reducing Bush	
5180		
Page 32	BUCCHI Tank Adaptor Male Threaded - EPDM	
5180		
Page 32	BUCCHI Tank Adaptor Male - Female Threaded - EPDM	
5180		
Page 32	BUCCHI Tank Adaptor Male - Female Threaded - FPM	



ENGINEERED FOR STRENGTH, CERTIFIED FOR QUALITY

Plasson threaded fittings are manufactured from Polypropylene for increased strength and enhanced chemical resistance.

Plasson's range of threaded fittings are certified to AS/NZS 4129 and hold both ISO Type 5 and WaterMark licenses. Plasson threaded fittings are made to ISO 7.1 which is equivalent to Australian Standard AS ISO 7.1.

Male threads are tapered. Known as BSPT, these fittings are referred to as R threads in the standard. Female threads are parallel. Known as BSPP, these fittings are referred to as Rp in the standard. When these threads are screwed together, with the use of a jointing medium, typically Teflon thread tape, a seal is formed.

The enhanced stiffness of the Plasson Polypropylene threaded fittings ensures a good seal between the threads of the male and female parts.

In some applications products are designed with a BSP taper female thread, Rc, which is designed for sealing with a BSP taper male, R. Teflon tape or another jointing medium is required with this connection.

OTHER THREAD STANDARDS

Other thread types are found within Australia, usually in the hydraulic and gas industry.

The hydraulic industry often uses a "G" thread. While of similar form to the Rp thread, the "G" thread is designed to seal with an o-ring or washer.

NPT threads are often used in the Gas industry. The NPT thread has a thread angle of 55° compared with 60° of the BSP range of fittings. While it is common to interchange these threads it is not recommended.

METRIC THREAD SIZE	SIZE
DN6	1/8"
DN8	1/4"
DN10	3/8"
DN15	1/2"
DN20	3/4"
DN25	1"
DN32	1.1/4"
DN40	1.1/2"
DN50	2"
DN65	2.1/2"
DN80	3"

90° Threaded Tee

5050

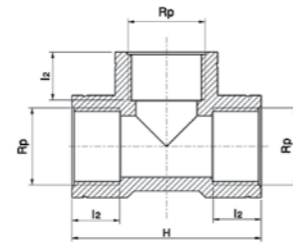

Product Code	Size Rp	H	I2	Bag	Carton	W	PN
5040001	1/2"	64	18	10	700	28	16
5040002	3/4"	68	19	10	500	39	16
5040003	1"	81	21	10	260	61	16
5040006	1 1/4"	96	25	5	140	114	10
5040004	1 1/2"	108	25	5	90	157	10
5040005	2"	130	30	5	60	205	10

90° Threaded Elbow

5050

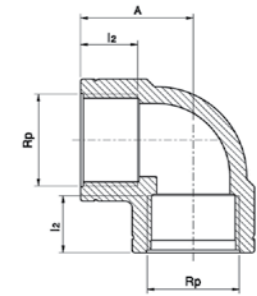

Product Code	Size Rp	A	I2	Bag	Carton	W	PN
5050001	1/2"	32	17	10	1000	22	16
5050002	3/4"	35	18	10	700	30	16
5050003	1"	41	21	10	400	45	16
5050004	1 1/4"	48	25	10	200	87	10
5050005	1 1/2"	54	25	5	150	116	10
5050006	2" x 2"	65	30	5	80	157	10

90° Threaded Tee with S/S Reinforcing Ring

5041

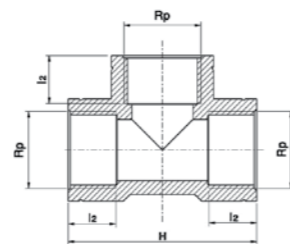

Product Code	Size Rp	H	I2	Bag	Carton	W	PN
5041001	1.1/4"	96	25	5	150	140	16
5041002	1.1/2"	108	25	5	204	90	16
5041003	2"	30	30	5	226	60	16

90° Threaded Elbow with S/S Reinforcing Ring

5051

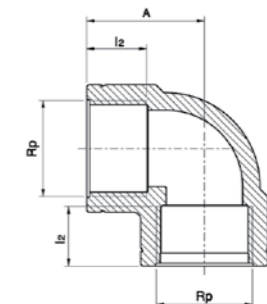

Product Code	Size Rp	A	I2	Bag	Carton	W	PN
5051001	1 1/4"	48	25	10	200	111	16
5051002	1 1/2"	54	25	5	140	147	16
5051003	2"	65	30	5	80	190	16

90° Threaded Elbow Male x Female

5150

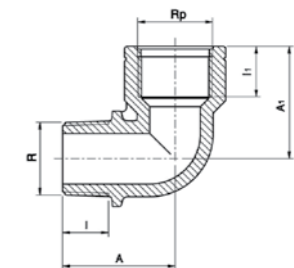

Product Code	Size R x Rp	A	A1	I	I1	Bag	Carton	W	PN
5150001	1/2" x 1/2"	36	36	16	17	10	1000	17	16
5150002	3/4" x 3/4"	40	40	17	18	10	700	25	16
5150003	1" x 1"	45	47	19	21	10	400	40	16

Threaded Nipple

5060

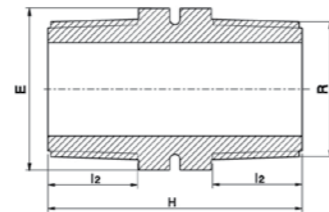

Product Code	Size R	H	I2	E	Bag	Carton	W	PN
5060001	1/2" x 1/2"	47	17	22	10	1800	8	16
5060002	3/4" x 3/4"	49	18	27	10	1500	11	16
5060003	1" x 1"	55	20	36	10	800	23	16
5060004	1 1/4" x 1 1/4"	60	22	46	10	400	35	16
5060005	1 1/2" x 1 1/2"	61	22	50	5	300	48	16
5060006	2" x 2"	71	26	65	5	180	78	16

Threaded Reducing Nipple

5060

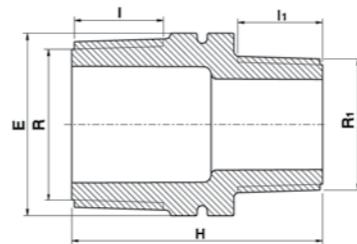

Product Code	Size R x R1	A	A1	I	I1	Bag	Carton	W	PN
5060007	3/4" x 1/2"	47	17	17	16	10	1500	10	16
5060008	1" x 1/2"	49	19	19	16	10	800	17	16
5060009	1" x 3/4"	50	19	19	17	10	800	18	16
5060010	1 1/4" x 1/2"	53	21	21	16	10	500	28	16
5060011	1 1/4" x 3/4"	54	21	21	17	10	500	29	16
5060012	1 1/4" x 1"	56	21	21	19	10	500	31	16
5060013	1 1/2" x 1/2"	54	21	21	16	5	500	34	16
5060014	1 1/2" x 3/4"	55	21	21	17	5	500	34	16
5060015	1 1/2" x 1"	57	21	21	19	5	400	36	16
5060016	1 1/2" x 1 1/4"	59	21	21	21	5	400	39	16
5060017	2" x 1/2"	58	25	25	16	5	280	51	16
5060018	2" x 3/4"	59	25	25	17	5	260	52	16
5060019	2" x 1"	61	25	25	19	5	260	53	16
5060020	2" x 1 1/4"	63	25	25	21	5	240	57	16
5060021	2" x 1 1/2"	63	25	25	21	5	240	58	16

Threaded Plug

5170

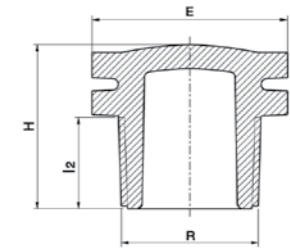

Product Code	Size R	H	I2	E	Bag	Carton	W	PN
5170001	3/8"	24	13	22	10	4500	4	16
5170002	1/2"	29	16	27	10	2000	8	16
5170003	3/4"	31	17	32	10	1500	12	16
5170004	1"	34	19	36	10	1000	16	16
5170005	1 1/4"	38	21	46	10	700	26	16
5170006	1 1/2"	39	21	55	10	500	38	16
5170007	2"	45	25	65	10	300	60	16

Threaded Cap

5070

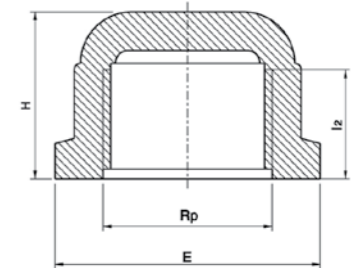

Product Code	Size Rp	E	H	I2	Bag	Carton	W	PN
5070001	1/2"	37	25	15	10	1600	13	16
5070002	3/4"	42	26	16	10	1500	14	16
5070003	1"	50	32	19	10	800	27	16
5070004	1 1/4"	59	34	22	10	500	39	10
5070005	1 1/2"	65	34	21	10	450	43	10
5070006	2"	80	39	25	5	250	78	10

Threaded Socket

5010

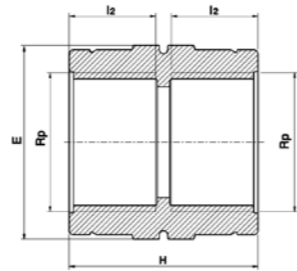

Product Code	Size Rp	H	I2	E	Bag	Carton	W	PN
5010001	1/2"	39	17	30	10	1200	15	16
5010002	3/4"	41	19	36	10	1000	19	16
5010003	1"	45	21	46	10	600	31	16
5010004	1.1/4"	54	25	60	10	250	65	10
5010005	1.1/2"	54	25	65	10	250	76	10
5010006	2"	66	31	75	5	150	94	10

Threaded Riser

5160

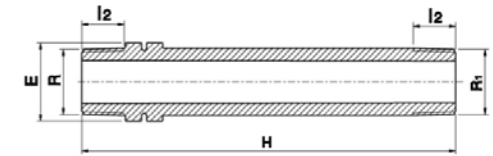

Product Code	Size R x R1	H	I2	E	Bag	Carton	W	PN
5160001	1/2" x 1/2"	150	17	22	10	600	30	16
5160002	3/4" x 1/2"	113	18	27	10	500	26	16
5160003	3/4" x 3/4"	150	18	27	10	400	43	16
5160004	1" x 1"	150	19	36	5	250	65	16
5160005	1 1/4" x 1 1/4"	150	21	46	5	150	93	16
5160006	1 1/2" x 1 1/4"	150	21	50	5	140	120	16
5160007	1 1/2" x 1 1/2"	150	21	50	5	140	120	16

Threaded Socket with S/S Reinforcing Ring

5011

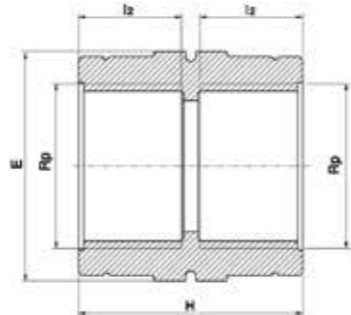

Product Code	Size Rp	H	I2	E	Bag	Carton	W	PN
5011001	1.1/4"	54	25	60	10	250	89	16
5011002	1.1/2"	54	25	65	10	240	107	16
5011003	2"	65	30	75	5	150	12	16

Threaded Reducing Bush

5020

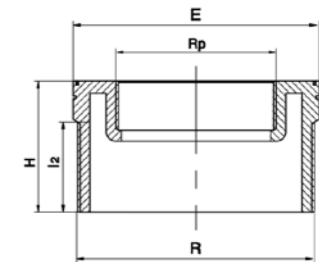

Product Code	Size R x Rp	H	I2	E	Bag	Carton	W	PN
5020001	3/4" x 1/2"	30	17	27	10	2000	6	16
5020002	1" x 1/2"	32	19	36	10	1000	16	16
5020003	1" x 3/4"	32	19	36	10	1000	11	16
5020004	1.1/4" x 1/2"	37	21	46	10	700	27	16
5020005	1.1/4" x 3/4"	37	21	46	10	700	28	16
5020006	1.1/4" x 1"	37	21	46	10	700	21	16
5020007	1.1/2" x 1/2"	37	21	50	10	600	34	16
5020008	1.1/2" x 3/4"	37	21	50	10	600	32	16
5020009	1.1/2" x 1"	37	21	50	10	500	32	16
5020010	1.1/2" x 1.1/4"	37	21	50	10	500	20	10
5020011	2" x 1/2"	41	25	63	5	350	60	16
5020012	2" x 3/4"	41	25	63	5	350	58	16
5020013	2" x 1"	41	26	63	5	300	61	16
5020014	2" x 1.1/4"	41	26	63	5	320	55	10
5020015	2" x 1.1/2"	41	26	63	5	320	44	10
5020016	2.1/2" x 2"	44	29	80	5	200	75	10
5020017	3" x 1"	48	32	90	2	150	117	16
5020018	3" x 1.1/4"	48	32	90	2	150	119	10
5020019	3" x 1.1/2"	48	32	90	2	150	118	10
5020020	3" x 2"	48	32	90	2	100	103	10
5020021	3" x 2.1/2"	48	32	90	2	150	75	10
5020022	4" x 2"	56	41	120	2	80	238	10
5020023	4" x 3"	56	41	120	2	80	222	10

Threaded Reducing Socket

5110

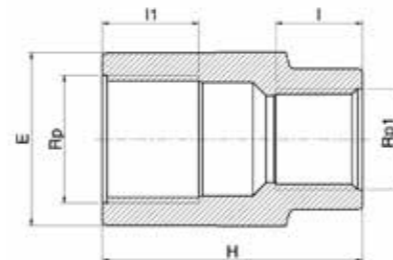

Product Code	Size Rp x Rp1	H	I	I1	E	Bag	Carton	W	PN
5110001	3/4" x 1/2"	50	20	19	36	10	800	24	16

BUCCHI Tank Adaptor Male Threaded - EPDM

5180

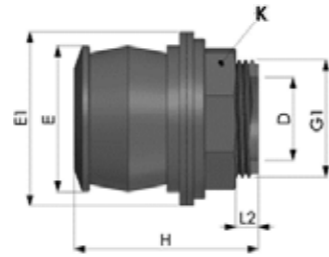

Product Code	Size G1	E	E1	D	H	K	L2
5180001	1/2"	29	37	13	49	23	5
5180002	3/4"	35	43	18	52	32	4
5180003	1"	43	53	24	56	41	7
5180004	1.1/4"	52	62	29.5	65	50	6
5180005	1.1/2"	59	68	34.5	75	57	16
5180006	2"	70	80	34.5	91	70	31

BUCCHI Tank Adaptor Male - Female Threaded - EPDM

5180

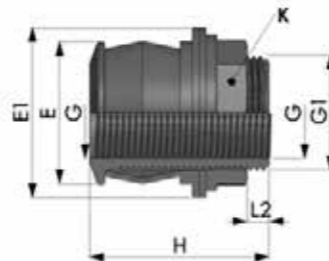

Product Code	Size G1x G	E	E1	H	K	L2
5180007	1/2" x 3/8"	29	38	49	28	5
5180008	3/4" x 1/2"	35	43	52	32	4
5180009	1" x 3/4"	43	53	56	41	7
5180010	1.1/4" x 1"	52	62	65	50	6
5180011	1.1/2" x 1.1/4"	59	68	75	57	16
5180012	2" x 1.1/2"	70	80	91	70	31

BUCCHI Tank Adaptor Male - Female Threaded - FPM

5180

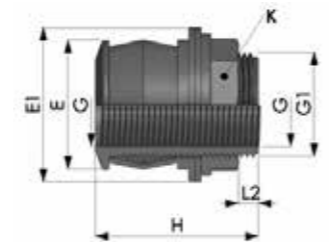

Product Code	Size G1x G	E	E1	H	K	L2
5180013	1/2" x 3/8"	29	37	49	28	8
5180014	3/4" x 1/2"	35	43	52	32	4
5180015	1" x 3/4"	43	53	56	41	7
5180016	1.1/4" x 1"	52	62	65	50	6
5180017	1.1/2" x 1.1/4"	59	68	75	57	15
5180018	2" x 1.1/2"	70	80	91	70	31



ONE PERSON INSTALL, FROM OUTSIDE THE TANK

BUCCHI Adaptors deliver a secure and reliable seal on tank walls 2mm to 12mm even on curved or uneven walls, for water, fuel and aggressive liquids. Available M and MF threaded 1/2" to 2".



PLASSON Australia is exclusive distributor for BUCCHI. Call us on 1300 752 776 or email sales@plasson.com.au to find out more.

SEE A BUCCHI TANK
CONNECTED

INSTALLATION









Adaptor Size	1/2"	3/4"	1"	1.1/4"	1.1/2"	2"
Male Thread EPDM	5180001	5180002	5180003	5180004	5180005	5180006
M/F Thread EPDM	5180007	5180008	5180009	5180010	5180011	5180012
M/F Thread FPM	5780013	5180014	5180015	5180016	5180017	5180018
Tank wall min thickness mm	2	2	2	4	4	4
Tank wall max thickness mm	8	9	10	12	12	12
Drill hole size mm	29	35	43	52	59	70





 PLASSON

METRIC COMPRESSION FITTINGS











Metric Compression Fittings

7010		
Page 42	Metric Coupling	
7610		
Page 42	Metric Slip Repair Coupling	
7010		
Page 43	Metric Coupling Body	
7610		
Page 43	Universal Slip Repair Coupling	
7110		
Page 44	Metric Reducing Coupling	
7020		
Page 45	Metric Male Adaptor	
7030		
Page 46	Metric Female Adaptor	
7037		
Page 46	Metric Female Adaptor with Parallel Thread	
7320		
Page 47	Metric Shouldered Adaptor	

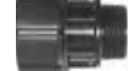



7120		
Page 47	Metric End Plug (Cap)	
7050		
Page 48	Metric 90° Elbow	
7510		
Page 48	Metric 90° Reducing Elbow	
7850		
Page 49	Metric 90° Elbow with Threaded Male Offtake	
7470		
Page 49	Metric Adjustable Elbow	
7150		
Page 50	Metric 90° Elbow with Threaded Female Offtake	
7060		
Page 50	Metric 45° Elbow	
7450		
Page 51	Metric 45° Elbow with Threaded Male Offtake	
7350		
Page 51	Metric 90° Elbow Adaptor	

7040		
Page 52	Metric 90° Tee	
7046		
Page 52	Metric 90° Slip Tee	
7740		
Page 53	Metric 90° Enlarging Tee	
7340		
Page 53	Metric 90° Reducing Tee	
7840		
Page 54	Metric 90° Tee with Threaded Male Offtake	
7146		
Page 54	Metric 90° Reducing Tee with Threaded Female Offtake	
7140		
Page 55	Metric 90° Tee with Threaded Female Offtake	
7146		
Page 55	Metric 90° Slip Tee with Threaded Female Offtake	
7810		
Page 56	Metric Coupling with Riser	





7640		
Page 56	Metric 45° Tee	
7220		
Page 57	Compression Flange Adaptor (with Metal Flange)	
7230		
Page 58	Metric Flange Adaptor (with Metal Flange)	
7006		
Page 58	Metric Metal Flange	
7250		
Page 59	Metric Barrel Union Adaptor with Male Thread	
7017		
Page 59	Metric Universal Coupling	
7057		
Page 60	Metric 90° Universal Elbow	
7550		
Page 60	Metric Y Fitting with Threaded Male Offtake	
7540		
Page 60	Metric Cross with Threaded Female Offtake	



Conversion & Adaptor Sets

7120		
Page 61	Metric Plug Adaptor	
7930		
Page 61	Metric Reducing Set	
7940		
Page 62	Metric Modular Adaptor	
7113		
Page 62	Metric Copper Pipe Adaptor	
7043		
Page 63	Metric Poly to Copper Tee	
7056		
Page 63	Metric Poly to Copper Elbow	
3408		
Page 63	Metric Poly to Copper Stopcock	
7043		
Page 64	Metric Plasscom Coupling	
7112		
Page 64	Metric Poly to Polybutylene Connector	

7435		
Page 64	Metric Poly to Polybutylene Kit	
7970		
Page 65	Metric Grip Ring for UPVC and PP Pipe	
7439		
Page 65	Metric Conversion Set for Copper Pipe	
7016		
Page 65	Metric Poly to Series 1 PVC Connector	

Accessories for Compression Fittings

7002		
Page 66	Metric O - Rings	
7002		
Page 66	Metric Trapeze Rings	
7003		
Page 67	Metric Split Rings	
7004		
Page 67	Metric Nut	

7005		
Page 68	Metric Insert	
7960		
Page 68	Metric Chamfer Tool for PE Pipes	
7990		
Page 68	Metric Wrench	

Fittings for 160mm Pipes

7010		
Page 69	Metric Coupling	
7610		
Page 69	Metric Repair Coupling	
7040		
Page 69	Metric 90° Tee	
7050		
Page 70	Metric 90° Elbow	
7220		
Page 70	Metric Compression Flange Adaptor (with Metal Flange)	

7230		
Page 70	Metric Flange Adaptor (with Metal Flange)	
7320		
Page 71	Metric Shouldered Adaptor	
7006		
Page 71	Metric Half Metal Flange	

Mine Fittings

7015		
Page 72	Metric Mine Coupling	
7615		
Page 72	Metric Mine Repair Coupling	
7115		
Page 72	Metric Mine Reducing Coupling	
7025		
Page 73	Metric Mine Male Adaptor	
7035		
Page 73	Metric Mine Female Adaptor	

- 7325**

Page 73 | Metric Mine Shouldered Adaptor 
- 7055**

Page 74 | Metric Mine 90° Elbow 
- 7855**

Page 74 | Metric Mine - 90° Elbow with Threaded Male Offtake 
- 7155**

Page 74 | Metric Mine - 90° Elbow with Threaded Female Offtake 
- 7065**

Page 75 | Metric Mine - 45° Elbow 
- 7045**

Page 75 | Metric Mine - 90° Tee 
- 7046**

Page 75 | Metric Mine - 90° Slip Tee 
- 7345**

Page 76 | Metric Mine - 90° Reducing Tee 
- 7845**

Page 76 | Metric Mine - 90° Tee with Threaded Male Offtake 

- 7145**

Page 76 | 90° Tee with Threaded Female Offtake 
- 7125**

Page 77 | Metric Mine - End Plug 
- 7225**

Page 77 | Metric Mine - Flange Coupling 
- 7930**

Page 77 | Metric Mine - Reducing Set 
- 7120**

Page 78 | Mine Spray Nozzle 



THE LONG LASTING COMPRESSION FITTINGS

PLASSON POLY PIPE JOINERS: ENGINEERED FOR DURABILITY AND RELIABILITY

RELIABLE AND DURABLE PIPE JOINERS

Plasson's poly pipe joiners are meticulously engineered to endure a multitude of conditions, including ground movement, ensuring unwavering performance over time. Equipped with unique captive o-rings, these joiners establish instant watertight seals upon installation, promising leak-free connections that withstand the test of time.

Our metric compression fittings, boasting a PN16 rating, offer a combination of corrosion resistance, UV stabilisation, and lightweight yet robust construction. They provide rapid and dependable connections for PE pipelines, spanning from 16mm to 125mm to accommodate various domestic plumbing needs, as well as irrigation and civil applications.

SEAMLESS PIPE JOINING SOLUTIONS

When it comes to efficient and effortless pipe connections, Plasson is the name to trust. Our range includes fast-fit Poly-to-Copper joiners, also PN16-rated, designed to streamline the installation process for both high and low-pressure pipelines. Engineered for strength and reliability, these fittings create strong, watertight connections between poly pipe and copper tube.

Available in a range of sizes and featuring color-coded ends for easy identification—black for PE pipe and brown nut for copper pipe—PLASSON joiners ensure a hassle-free installation experience. Experience the unmatched reliability and longevity of PLASSON compression fittings, providing steadfast connections for PN16 blue-line PE pipe applications.

Metric Coupling

7010

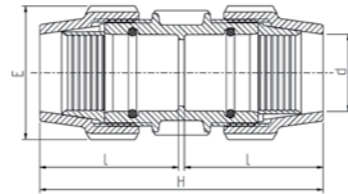

Product Code	Size d x d	E	H	I	Bag	Carton	W	PN
7010001	16 x 16	39	105	50	10	400	52	16
7010013	20 x 20	48	122	59	10	200	93	16
7010014	25 x 25	54	126	61	10	180	116	16
7010015	32 x 32	64	145	71	5	100	181	16
7010016	40 x 40	82	177	87	1	75	310	16
7010017	50 x 50	96	201	98	1	45	457	16
7010018	63 x 63	113	230	113	1	30	741	16
7010019	75 x 75	134	278	138	1	16	1183	16
7010020	90 x 90	154	335	165	1	10	1898	16
7010021	110 x 110	181	393	194	1	5	3129	16
7010022	125 x 125	212	460	225	1	3	5347	16
7010023	160 x 160	See fittings for 160mm pipes from page 72						

63mm also available in Mine style. See full range at end of Metric Section.

Metric Slip Repair Coupling

7610

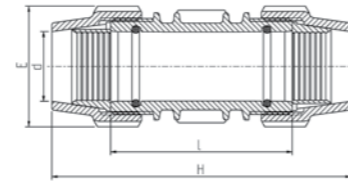

Product Code	Size d x d	E	H	I	Bag	Carton	W	PN
7610001	20 x 20	48	122	78	10	240	141	16
7610002	25 x 25	54	136	90	10	150	119	16
7610003	32 x 32	64	174	120	5	80	202	16
7610004	40 x 40	82	215	148	1	55	360	16
7610005	50 x 50	96	244	158	1	30	536	16
7610006	63 x 63	113	270	170	1	24	836	16
7610007	75 x 75	134	278	139	1	16	1178	16
7610008	90 x 90	154	335	168	1	10	1852	16
7610009	110 x 110	181	393	197	1	5	3098	16
7610010	125 x 125	212	460	265	1	3	5318	16
7610011	160 x 160	See fittings for 160mm pipes from page 72						

Metric Coupling Body

7010

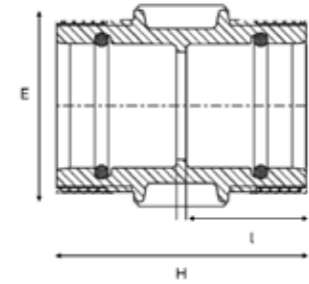

Product Code	Metric (d)	H	E	I	Bag
7010007	16	138	48	28	1
7010008	20	144	54	30	1
7010009	25	169	64	37	1
7010010	32	214	82	50	1
7010011	40	219	96	50	1
7011012	50	113	85	51	1
7010024	63	130	95	65	1

Universal Slip Repair Coupling

7610

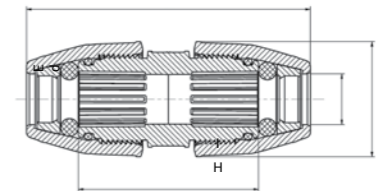

Product Code	Size d	E	H	I	Bag	Carton	W	PN
7610018	14-18	54	180	119	1	120	220	16
7610017	19-22	58	180	119	1	90	250	16
7610012	24-28	66	200	133	1	56	345	16
7610013	31-35	76	210	143	1	40	467	16
7610014	40-43	89	250	151	1	30	717	16
7610015	48-51	101	270	158	1	20	968	16
7610016	60-64	120	310	176	1	10	1517	16

Suitable for PE, REX, PVC, PP, Gal and copper pipes with outside diameter that suits the fitting size range.

Metric Reducing Coupling

7110

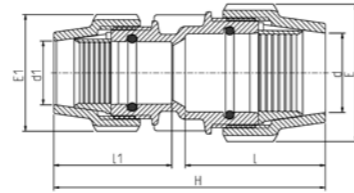

Product Code	Size d x d1	E	E1	H	I	L1	Bag	Carton	W	PN
7110011	20 x 16	48	39	111	57	50	10	300	74	16
7110012	25 x 16	54	39	113	58	50	10	220	88	16
7110013	25 x 20	54	48	119	58	57	10	200	100	16
7110014	32 x 20	64	48	140	67	57	5	150	142	16
7110015	32 x 25	64	54	133	67	58	5	120	143	16
7110016	40 x 25	82	54	156	84	58	1	90	219	16
7110017	40 x 32	82	64	156	84	67	1	90	245	16
7110018	50 x 25	96	54	176	93	58	1	70	305	16
7110019	50 x 32	96	64	175	98	62	1	70	332	16
7110020	50 x 40	96	82	184	93	84	1	60	381	16
7110021	63 x 25	113	54	193	110	58	1	50	461	16
7110022	63 x 32	113	64	197	110	62	1	45	486	16
7110023	63 x 40	113	82	208	110	82	1	40	546	16
7110024	63 x 50	113	96	214	110	93	1	36	574	16
7110025	75 x 50	134	96	245	132	98	1	22	846	16
7110026	75 x 63	134	113	252	132	112	1	20	960	16
7110027	90 x 63	154	113	292	170	115	1	14	1415	16
7110028	90 x 75	154	134	330	170	134	1	12	1609	16
7110029	110 x 63	181	181	393	194	131	1	5	3695	16
7110030	110 x 90	181	154	378	194	162	1	6	2643	16

Metric Male Adaptor

7020

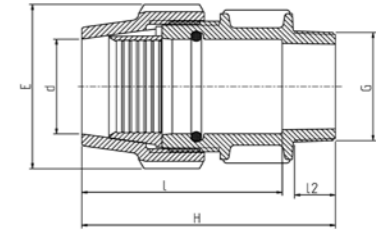

Product Code	Size d x R	E	H	I	I2	Bag	Carton	W	PN
7020001	16 x 1/2"	39	79	59	16	10	500	34	16
7020002	16 x 3/4"	39	79	59	17	10	500	35	16
7020021	20 x 1/2"	48	92	71	17	10	350	58	16
7020022	20 x 3/4"	48	92	71	18	10	350	59	16
7020023	20 x 1"	48	86	52	20	10	350	60	16
7020024	25 x 1/2"	54	94	72	17	10	250	68	16
7020025	25 x 3/4"	54	95	72	18	10	250	73	16
7020026	25 x 1"	54	97	72	20	10	250	79	16
7020027	32 x 3/4"	64	106	83	18	5	150	113	16
7020028	32 x 1"	64	107	83	20	5	150	122	16
7020029	32 x 1 1/4"	64	110	83	22	5	150	114	16
7020030	32 x 1 1/2"	64	110	83	22	5	140	127	16
7020031	40 x 1"	82	118	91	20	1	110	184	16
7020032	40 x 1 1/4"	82	117	90	22	1	110	185	16
7020033	40 x 1 1/2"	82	117	90	22	1	100	185	16
7020034	40 x 2"	82	123	91	26	1	100	208	16
7020035	50 x 1"	96	133	106	20	1	70	266	16
7020036	50 x 1 1/4"	96	136	106	22	1	70	266	16
7020037	50 x 1 1/2"	96	136	109	22	1	70	277	16
7020038	50 x 2"	96	140	109	26	1	65	284	16
7020039	63 x 1 1/4"	113	154	123	22	1	48	443	16
7020040	63 x 1 1/2"	113	154	123	22	1	48	451	16
7020041	63 x 2"	113	167	123	26	1	48	461	16
7020042	63 x 2 1/2"	113	160	123	29	1	45	459	16
7020043	75 x 2"	132	188	150	26	1	28	710	16
7020044	75 x 2 1/2"	132	191	150	29	1	28	712	16
7020045	75 x 3"	132	195	150	33	1	25	718	16
7020046	90 x 2"	152	227	170	26	1	16	1123	16
7020047	90 x 2 1/2"	152	229	170	29	1	16	1142	16
7020048	90 x 3"	152	232	170	33	1	16	1133	16
7020049	90 x 4"	152	239	170	40	1	16	1226	16
7020050	110 x 2"	181	261	213	26	1	10	1845	16
7020051	110 x 3"	181	256	213	34	1	10	1850	16
7020052	110 x 4"	181	265	213	42	1	8	1872	16

Metric Female Adaptor

7030

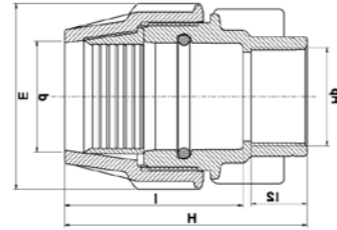

Product Code	Size d x Rp	E	H	I	I2	Bag	Carton	W	PN
7030001	16 x 1/2"	39	73	52	19	10	500	36	16
7030002	16 x 3/4"	39	75	53	19	10	500	36	16
7030017	20 x 1/2"	48	82	60	19	10	350	60	16
7030018	20 x 3/4"	48	82	60	19	10	350	58	16
7030019	20 x 1"	48	92	57	21	10	300	68	16
7030020	25 x 3/4"	54	88	63	21	10	250	83	16
7030021	25 x 1"	54	88	63	21	10	250	78	16
7030022	32 x 3/4"	64	94	73	19	5	150	107	16
7030023	32 x 1"	64	94	69	21	5	150	115	16
7030024	32 x 1 1/4"	64	96	67	25	5	140	140	16
7030025	40 x 1"	82	112	84	21	1	110	178	16
7030026	40 x 1 1/4"	82	114	84	25	1	110	202	16
7030027	40 x 1 1/2"	82	114	84	25	1	100	225	16
7030028	50 x 1 1/4"	96	123	93	25	1	75	276	16
7030029	50 x 1 1/2"	96	123	93	25	1	70	277	16
7030030	50 x 2"	96	128	93	30	1	70	294	16
7030031	63 x 1 1/4"	113	139	110	25	1	48	417	16
7030032	63 x 1 1/2"	113	139	110	25	1	48	438	16
7030033	63 x 2"	113	148	110	30	1	48	443	16
7030034	75 x 2"	132	175	132	30	1	28	662	16
7030035	75 x 2 1/2"	132	170	132	33	1	28	683	16
7030036	90 x 2"	154	213	183	30	1	16	1138	16
7030037	90 x 3"	154	223	183	40	1	16	1204	6.3
7030038	90 x 4"	154	243	183	52	1	12	1444	6.3
7030039	110 x 3"	181	261	213	40	1	8	1919	6.3
7030040	110 x 4"	181	271	213	50	1	8	2048	6.3

Metric Female Adaptor with Parallel Thread

7037

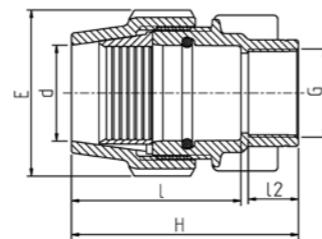

Product Code	Size d x G	E	H	I	I2	Bag	Carton	W	PN
7037001	25 x 3/4"	54	88	63	12	10	250	83	16
7037002	25 x 1"	54	88	63	14	10	250	78	16
7037003	32 x 1"	64	89	72	14	5	150	115	16

For connecting Male Parallel Threads - contains rubber seal in seat.

Metric Shouldered Adaptor

7320

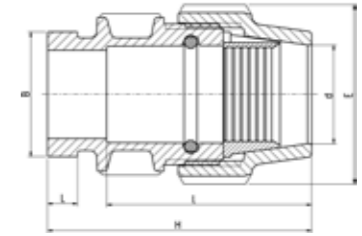

Product Code	Size d x DN (inch)	E	I	L	H	B	Bag	Carton	W	PN
7320001	50 x 50 (2")	96	109	16	138	67	1	65	293	16
7325001	63 x 50 (2")	113	123	16	156	67	1	45	437	16
7320002	90 x 100 (4")	154	170	16	231	123	1	16	1213	16
7320005	110 x 50 (2")	181	213	16	260	67	1	8	1900	16
7320003	110 x 100 (4")	181	213	16	255	123	1	8	1874	16
7320004	160 x 150 (6")	See fittings for 160mm pipes from page 72								

WARNING

Check shouldered coupling suitability for use with Plasson shouldered adaptors with the coupling manufacturer. Victaulic® style SC77 couplings are not suitable for use with Plasson shouldered adaptors.

Metric End Plug (Cap)

7120

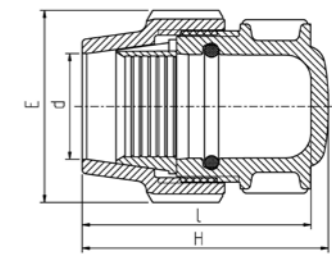

Product Code	Size d	E	I	H	Bag	Carton	W	PN
7120010	20	48	74	79	10	350	57	16
7120011	25	54	77	82	10	250	72	16
7120012	32	64	87	92	5	180	108	16
7120013	40	82	97	102	1	110	186	16
7120014	50	96	114	121	1	75	270	16
7120015	63	113	122	145	1	45	448	16
7120016	75	134	155	172	1	28	710	16
7120017	90	154	170	212	1	16	1139	16
7120018	110	181	213	231	1	10	1835	16

Metric 90° Elbow

7050

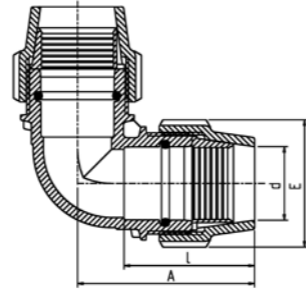

Product Code	Size d x d	E	I	A	Bag	Carton	W	PN	
7050001	16 x 16	39	50	63	10	350	57	16	
7050007	20 x 20	48	56	73	10	200	95	16	
7050008	25 x 25	54	58	79	10	150	122	16	
7050009	32 x 32	64	67	93	5	100	187	16	
7050010	40 x 40	82	82	108	1	60	341	16	
7050011	50 x 50	96	93	127	1	35	497	16	
7050012	63 x 63	113	110	151	1	24	838	16	
7050013	75 x 75	134	132	178	1	12	1304	16	
7050014	90 x 90	154	162	217	1	8	2168	16	
7050015	110 x 110	181	194	292	1	4	3810	16	
7050016	160 x 160	See fittings for 160mm pipes from page 72							

Metric 90° Reducing Elbow

7510

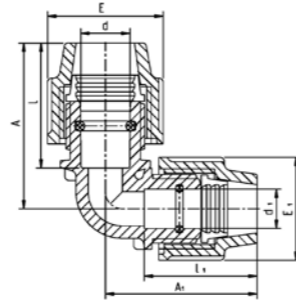

Product Code	Size d x D1	E	E1	I	I1	A	A1	Bag	Carton	W	PN
7510001	25 x 20	54	48	58	57	90	75	10	180	114	16

Metric 90° Elbow with Threaded Male Offtake

7850

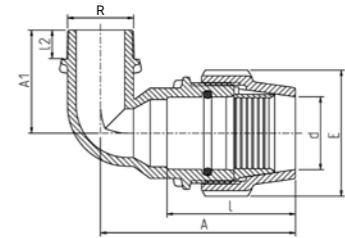

Product Code	Size d x R	E	I	I2	A	A1	Bag	Carton	W	PN
7850016	20 x 1/2"	48	57	17	74	41	10	350	55	16
7850017	20 x 3/4"	48	57	18	76	43	10	300	64	16
7850018	25 x 1/2"	54	58	17	85	47	10	240	70	16
7850019	25 x 3/4"	54	58	18	90	48	10	250	79	16
7850020	25 x 1"	54	58	20	90	54	10	240	84	16
7850021	32 x 3/4"	64	67	18	104	55	5	140	116	16
7850022	32 x 1"	64	67	20	104	55	5	140	128	16
7850023	32 x 1 1/4"	64	67	22	104	58	5	140	135	16
7850024	40 x 1"	82	84	20	124	60	1	90	196	16
7850025	40 x 1 1/4"	82	84	22	124	66	1	90	205	16
7850026	40 x 1 1/2"	82	84	22	124	66	1	80	220	16
7850027	50 x 1"	96	93	20	140	71	1	55	294	16
7850028	50 x 1 1/4"	96	93	22	144	74	1	55	335	16
7850029	50 x 1 1/2"	96	93	22	144	74	1	55	321	16
7850030	50 x 2"	96	93	26	144	76	1	55	373	16
7850031	63 x 1 1/4"	113	110	22	168	76	1	35	451	16
7850032	63 x 1 1/2"	113	110	22	168	76	1	35	468	16
7850033	63 x 2"	113	110	26	170	92	1	35	518	16
7850034	75 x 2 1/2"	134	132	30	202	105	1	18	872	16
7850035	75 x 3"	134	132	33	202	110	1	18	892	16
7850036	90 x 3"	154	165	35	233	110	1	12	1300	16
7850037	110 x 4"	181	194	42	274	140	1	6	2258	16

Metric Adjustable Elbow

7470

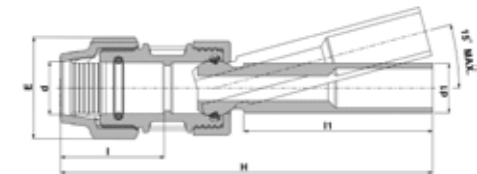

Product Code	Size d x d1	A	E	I	i1	H	Bag	Carton	W	PN
7470001	32 x 32	15° max.	64	71	40	257	5	100	240	16
7470002	40 x 40	15° max.	82	87	153	301	1	50	430	16
7470003	50 x 50	15° max.	96	98	173	340	1	35	630	16
7470004	63 x 63	15° max.	113	113	195	384	1	20	1110	16
7470005	90 x 90	15° max.	154	165	246	502	1	8	2370	16
7470006	110 x 110	15° max.	181	194	270	571	1	3	3820	16
7470007	125 x 125	15° max.	212	225	245	607	1	1	6140	16

Metric 90° Elbow with Threaded Female Offtake

7150

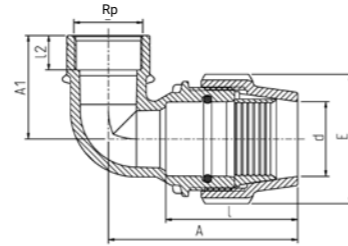

Product Code	Size d x Rp	E	I	I2	A	A1	Bag	Carton	W	PN
7150001	16 x 1/2"	39	50	19	66	39	10	500	38	16
7150018	20 x 1/2"	48	54	19	78	40	10	350	61	16
7150019	20 x 3/4"	48	57	19	78	44	10	300	71	16
7150020	25 x 1/2"	54	58	18	81	46	10	250	86	16
7150021	25 x 3/4"	54	58	19	81	46	10	250	81	16
7150022	25 x 1"	54	58	21	83	50	10	220	90	16
7150023	32 x 3/4"	64	67	18	95	54	5	150	143	16
7150024	32 x 1"	64	67	21	95	54	5	150	136	16
7150025	32 x 1 1/4"	64	67	25	99	60	5	120	167	16
7150026	40 x 1"	82	84	21	119	52	1	100	201	16
7150027	40 x 1 1/4"	82	84	25	119	62	1	90	246	16
7150028	40 x 1 1/2"	82	84	25	119	62	1	80	261	16
7150029	40 x 2"	82	84	30	119	75	1	65	293	16
7150030	50 x 1"	96	93	21	133	57	1	70	281	16
7150031	50 x 1 1/4"	96	93	25	133	67	1	60	313	16
7150032	50 x 1 1/2"	96	93	25	135	66	1	60	344	16
7150033	50 x 2"	96	93	30	138	85	1	45	387	16
7150034	63 x 1 1/4"	113	110	25	162	65	1	35	488	16
7150035	63 x 1 1/2"	113	110	25	162	69	1	35	504	16
7150036	63 x 2"	113	110	30	160	90	1	35	559	16
7150037	75 x 2"	134	132	30	188	100	1	24	810	16
7150038	75 x 2 1/2"	134	132	36	191	105	1	20	920	16
7150039	75 x 3"	134	132	36	191	105	1	20	956	6.3

Metric 45° Elbow

7060

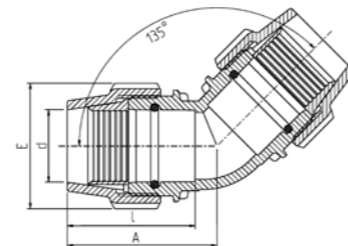

Product Code	Size d x d	E	I	A	Bag	Carton	W	PN
7060001	32 x 32	64	67	92	1	100	189	16
7060002	40 x 40	82	84	99	1	60	330	16
7060003	50 x 50	96	93	110	1	40	476	16
7060004	63 x 63	113	110	130	1	24	772	16
7060005	75 x 75	134	132	153	1	12	1207	16
7060006	90 x 90	154	165	195	1	8	2057	16
7060007	110 x 110	181	194	235	1	5	3418	16

Metric 45° Elbow with Threaded Male Offtake

7450

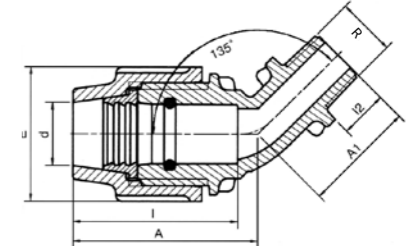

Product Code	Size d x R	E	I	I2	A	A1	Bag	Carton	W	PN
7450001	20 x 1/2"	48	57	17	64	40	10	350	54	16
7450002	20 x 3/4"	48	57	18	64	41	10	350	55	16

Metric 90° Elbow Adaptor

7350

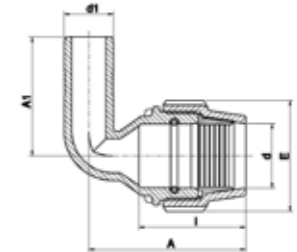

Product Code	Size d x d1	E	I	A	A1	Bag	Carton	W	PN
7350001	40 x 40	82	84	118	106	1	80	314	16
7350002	50 x 40	82	84	118	120	1	70	275	16
7350003	63 x 40	96	93	136	106	1	60	308	16
7350004	40 x 50	96	93	136	120	1	55	356	16
7350005	50 x 50	113	110	161	106	1	40	450	16
7350006	63 x 50	113	110	161	120	1	35	511	16

Metric Wall Plate Elbow

7750

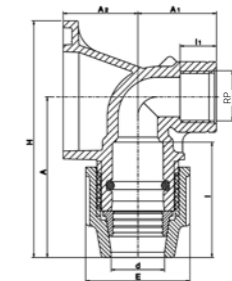

Product Code	Size d x Rp	E	I	I2	A	A1	A2	H	Bag	Carton	W	PN
7750001	16 x 1/2"	39	50	18	76	40	38	110	1	150	98	16
7750002	20 x 1/2"	48	57	18	78	40	38	110	1	150	92	16
7750003	25 x 3/4"	54	58	19	81	40	38	120	1	100	115	16

Metric 90° Tee

7040

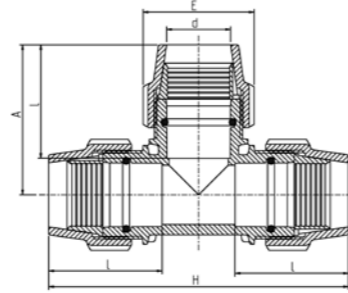

Product Code	Size d x d x d	E	H	I	A	Bag	Carton	W	PN
7040001	16 x 16 x 16	39	126	50	63	10	220	83	16
7040007	20 x 20 x 20	48	145	56	73	10	120	141	16
7040008	25 x 25 x 25	54	156	58	78	5	100	173	16
7040009	32 x 32 x 32	64	185	67	93	5	60	285	16
7040010	40 x 40 x 40	82	221	86	111	1	40	501	16
7040011	50 x 50 x 50	96	252	95	126	1	25	741	16
7040012	63 x 63 x 63	113	294	110	146	1	16	1215	16
7040013	75 x 75 x 75	132	353	132	177	1	8	1890	16
7040014	90 x 90 x 90	154	439	165	220	1	5	3161	16
7040015	110 x 110 x 110	181	583	194	292	1	2	5584	16
7040016	160 x 160 x 160	See fittings for 160mm pipes from page 72							

Metric 90° Slip Tee

7046

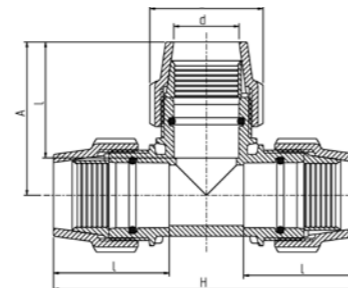

Product Code	Size d x d x d	E	H	I	A	Bag	Carton	W	PN
7046001	20 x 20 x 20	48	145	56	73	10	120	133	16
7046002	25 x 25 x 25	54	156	58	78	5	100	173	16
7046003	32 x 32 x 32	64	185	67	93	5	60	280	16
7046004	40 x 40 x 40	82	221	86	111	1	40	489	12.5
7046005	50 x 50 x 50	96	252	95	126	1	25	720	12.5
7046006	63 x 63 x 63	113	294	110	146	1	16	1107	12.5

Metric 90° Enlarging Tee

7740

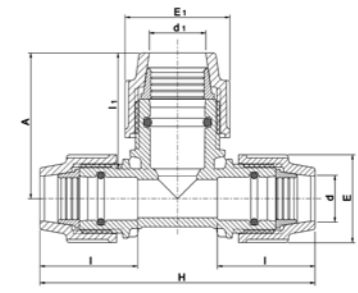

Product Code	Size d x d1 x d	E	E1	H	I	I1	A	Bag	Carton	W	PN
7740001	25 x 32 x 25	54	64	156	58	69	87	5	80	219	16

Metric 90° Reducing Tee

7340

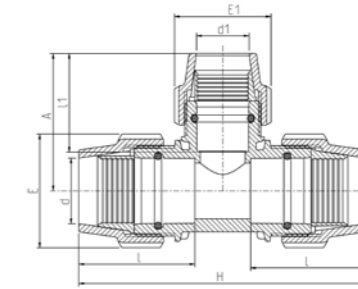

Product Code	Size d x d1 x d	E	E1	H	I	I1	A	Bag	Carton	W	PN
7340009	20 x 16 x 20	48	39	137	57	50	70	10	150	125	16
7340010	25 x 20 x 25	54	48	150	58	57	74	5	100	166	16
7340011	32 x 25 x 32	64	54	173	67	58	63	5	70	256	16
7340012	40 x 25 x 40	82	54	205	84	58	84	1	45	412	16
7340013	40 x 32 x 40	82	64	207	82	67	97	1	40	428	16
7340014	50 x 25 x 50	96	54	228	93	76	105	1	30	550	16
7340015	50 x 32 x 50	96	64	230	93	67	117	1	30	590	16
7340016	50 x 40 x 50	96	82	236	93	82	114	1	30	647	16
7340017	63 x 32 x 63	113	64	268	113	62	118	1	20	892	16
7340018	63 x 40 x 63	113	82	268	113	84	139	1	20	962	16
7340019	63 x 50 x 63	113	96	275	110	93	132	1	18	1021	16
7340020	75 x 63 x 75	132	113	353	132	109	153	1	10	1667	16
7240021	110 x 63 x 110	181	181	583	194	131	292	1	2	6127	16

Metric 90° Tee with Threaded Male Offtake

7840

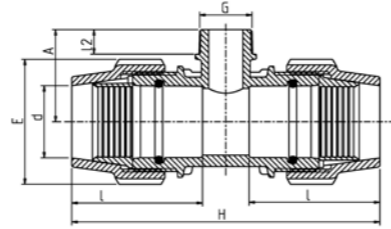

Product Code	Size d x R x d	E	H	I	I2	A	Bag	Carton	W	PN
7840010	20 x 1/2" x 20	48	138	56	17	46	10	180	105	16
7840011	20 x 3/4" x 20	48	144	56	18	46	10	180	108	16
7840012	25 x 1/2" x 25	54	146	58	17	48	5	140	134	16
7840013	25 x 3/4" x 25	54	146	58	18	50	5	140	137	16
7840014	32 x 1" x 32	64	170	67	20	58	5	80	218	16
7840015	40 x 1 1/4" x 40	82	205	84	22	71	1	50	373	16
7840016	40 x 1 1/2" x 40	82	205	84	22	71	1	50	376	16
7840017	50 x 1 1/4" x 50	96	230	93	22	77	1	36	511	16
7840018	50 x 1 1/2" x 50	96	230	93	22	77	1	36	523	16
7840019	50 x 2" x 50	96	230	93	26	82	1	36	523	16
7840020	63 x 1 1/4" x 63	113	268	113	22	79	1	20	821	16
7840021	63 x 1 1/2" x 63	113	268	113	22	83	1	20	828	16
7840022	63 x 2" x 63	113	272	110	26	92	1	20	877	16

Metric 90° Reducing Tee with Threaded Female Offtake

7146

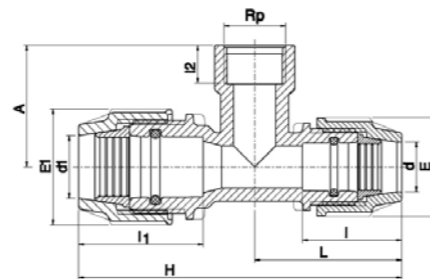

Product Code	Size d x Rp x d1	E	E1	H	L	I	I1	I2	A	Bag	Carton	W	PN
7146004	20 x 3/4" x 16	48	39	132	69	52	50	19	42	10	180	86	16
7146005	25 x 3/4" x 20	54	48	139	70	53	52	22	42	5	140	145	16
7146006	32 x 1" x 25	64	54	169	91	67	58	22	58	5	80	176	16

Metric 90° Tee with Threaded Female Offtake

7140

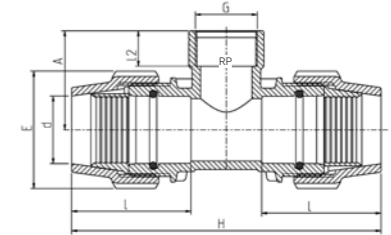

Product Code	Size d x Rp x d	E	H	I	I2	A	Bag	Carton	W	PN
7140001	16 x 1/2" x 16	39	122	50	17	42	10	240	66	16
7140002	16 x 3/4" x 16	39	122	50	19	41	10	240	65	16
7140021	20 x 1/2" x 20	48	144	56	18	42	10	180	104	16
7140022	20 x 3/4" x 20	48	144	56	19	45	10	180	110	16
7140023	25 x 1/2" x 25	54	151	58	18	45	5	140	131	16
7140024	25 x 3/4" x 25	54	151	58	19	48	5	140	140	16
7140025	25 x 1" x 25	54	158	58	21	53	5	100	140	16
7140026	25 x 1 1/4" x 25	54	158	58	25	64	5	80	194	16
7140027	32 x 3/4" x 32	64	177	67	19	51	5	80	210	16
7140028	32 x 1" x 32	64	177	67	21	54	5	80	213	16
7140029	32 x 1 1/4" x 32	64	182	67	25	65	5	60	253	16
7140030	32 x 1 1/2" x 32	64	182	67	25	71	5	60	268	16
7140031	40 x 1" x 40	82	203	84	21	61	1	60	357	16
7140032	40 x 1 1/4" x 40	82	217	84	24	70	1	55	403	16
7140033	40 x 1 1/2" x 40	82	217	84	25	70	1	50	413	16
7140034	40 x 2" x 40	82	217	84	30	78	1	45	435	16
7140035	50 x 1 1/2" x 50	96	244	93	25	76	1	36	575	16
7140036	50 x 2" x 50	96	244	93	30	80	1	30	590	16
7140037	63 x 1 1/4" x 63	113	268	113	27	95	1	20	886	16
7140038	63 x 1 1/2" x 63	113	268	113	27	95	1	20	898	16
7140039	63 x 2" x 63	113	272	110	30	95	1	20	903	16
7140040	75 x 2" x 75	134	359	132	30	110	1	10	1456	16
7140041	75 x 2 1/2" x 75	134	331	129	35	85	1	10	1502	16
7140042	75 x 3" x 75	134	359	132	36	110	1	10	1553	6.3
7140043	90 x 3" x 90	154	419	165	40	116	1	7	2354	6.3
7140044	110 x 4" x 110	181	511	198	50	140	1	4	3957	6.3

Metric 90° Slip Tee with Threaded Female Offtake

7146

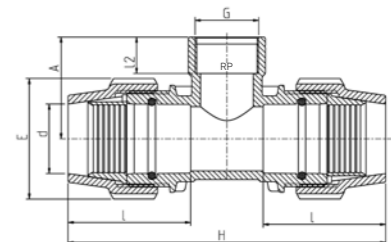

Product Code	Size d x Rp x d	E	H	I	I2	A	Bag	Carton	W	PN
7146001	40 x 1" x 40	82	203	84	21	61	1	60	361	12.5
7146002	50 x 1 1/2" x 50	96	244	93	25	76	1	36	587	12.5
7146003	63 x 1 1/4" x 63	113	268	113	27	95	1	20	860	12.5

Metric Coupling with Riser

7810

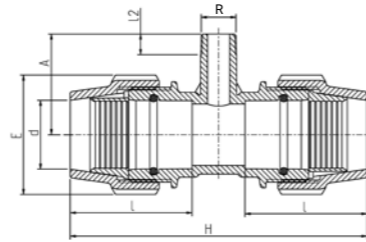

Product Code	Size d x R x d	E	I	I2	H	A	Bag	Carton	W	PN
7810001	40 x 3/4" x 40	82	89	18	215	85	1	50	366	16
7810002	50 x 3/4" x 50	96	98	18	244	90	1	36	512	16
7810003	50 x 1" x 50	96	98	20	244	90	1	36	551	16
7810004	63 x 3/4" x 63	113	110	18	270	95	1	24	822	16
7810005	63 x 1" x 63	113	110	20	270	95	1	24	820	16
7810006	75 x 3/4" x 75	134	132	18	313	105	1	16	1123	16
7810007	75 x 1" x 75	134	132	20	313	105	1	16	1240	16

Metric 45° Tee

7640

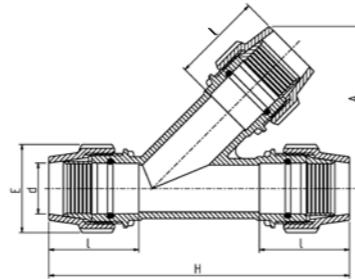

Product Code	Size d x d x d	E	H	I	A	Bag	Carton	W	PN
7640001	63 x 63 x 63	113	374	110	207	1	10	1432	8
7640002	75 x 75 x 75	132	435	132	204	1	5	2266	8
7640003	90 x 90 x 90	152	520	165	233	1	4	3600	8
7640004	110 x 110 x 110	181	625	194	284	1	2	6000	8

ISO Flanges to EN1092-1 PN16

Similar Australian Standard flanges can be bolted to EN1092-1 PN16 flanges, based on PCD, # holes and Ø holes. It is the user's responsibility to ensure suitability of these arrangements.

Other backing flanges are available. See Flange section for details.

ISO Size	OD	PCD	# Holes	Ø Holes	Thickness	Similar Flange	
						Description	Code
1.1/2"	150	110	4	18	18	2" TABLE E AS2129	8900036 8910036
2"	165	125	4	18	20	2.1/2" TABLE E AS2129	8900037 8910037
2.1/2"	185	145	8	18	20	3" TABLE E AS2129	8900038 8910038
4"	220	180	8	18	22	4" TABLE E AS2129	8900039 8910039
5"	250	210	8	18	22	5" TABLE E AS2129	8900041 8910041
6"	285	240	8	22	24	6" TABLE E AS2129	8900043 8910043

Compression Flange Adaptor (with Metal Flange)

7220

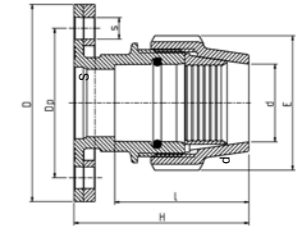

Product Code	Size d x ISO Flange	E	H	I	D	Dp	S	No. of Holes	Carton	W	PN	
7220001	50 x 40 (1.1/2")	96	128	93	150	110	18	4	20	1213	16	
7220002	50 x 50 (2")	96	128	93	165	125	18	4	15	1517	16	
7220003	63 x 50 (2")	113	145	110	165	125	18	4	015	1563	16	
7220004	75 x 65 (2.1/2)	134	164	152	185	145	18	4	012	2089	16	
7220005	90 x 100 (4")	154	195	183	220	180	18	8	8	3161	16	
7220006	110 x 100 (4")	181	235	222	220	180	18	8	8	3322	16	
7220007	125 x 125 (5")	212	270	250	250	210	22	8	4	5550	12.5	
7220008	125 x 150 (6")	212	270	250	285	240	22	8	3	7037	12.5	
7220009	160 x 125 (5")	See fittings for 160mm pipes from page 72										
7220010	160 x 150 (6")	See fittings for 160mm pipes from page 72										

Flange galvanised via electroplating then protected with a proprietary passivation process.

Metric Flange Adaptor (with Metal Flange)

7230

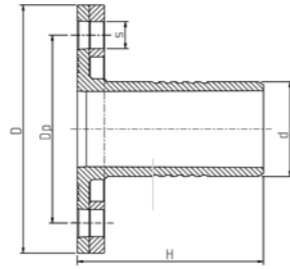

Product Code	Metric x ISO Flange	H	D	Dp	S	No. of Holes	Carton	W	PN
7230001	50 x 40 (1 1/2")	99	150	110	18	4	20	1064	16
7230002	50 x 50 (2")	99	165	125	18	4	20	1094	16
7230003	63 x 50 (2")	124	165	125	18	4	18	1311	16
7230004	63 x 65 (2 1/2")	124	185	145	18	4	15	1882	16
7230005	75 x 50 (2")	142	165	125	18	4	15	1402	16
7230006	75 x 65 (2 1/2")	142	185	145	18	4	15	1568	16
7230007	90 x 65 (2 1/2")	175	185	145	18	4	12	1833	16
7230008	90 x 80 (3")	175	200	160	18	8	12	1858	16
7230009	90 x 100 (4")	175	220	180	18	8	10	2181	16
7230010	110 x 80 (5")	210	200	160	18	8	10	2020	16
7230011	160 x 125 (5")	See fittings for 160mm pipes from page 72							
7230012	160 x 150 (6")								

Flange galvanised via electroplating then protected with a proprietary passivation process.

Metric Metal Flange

7006

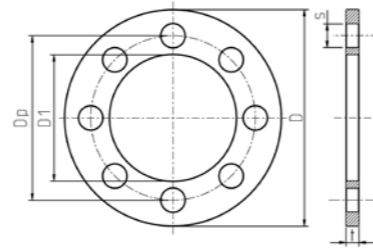

Product Code	Metric x ISO Flange	D	Dp	D1	S	t	No. of Holes	Carton	W
7006001	50 x 40 (1 1/2")	150	110	82	18	10	4	20	844
7006002	50 x 50 (2")	165	125	82	18	10	4	20	1141
7006003	63 / 75 x 50 (2")	185	145	96	18	10	4	20	1420
7006004	63 x 65 (2 1/2")	165	125	96	18	10	4	20	986
7006005	75 / 90 x 65 (2 1/2")	185	145	112	18	10	4	20	1350
7006006	90 x 100 (4")	200	160	112	18	10	8	15	1430
7006007	110 x 100 (4")	200	160	132	18	10	8	15	1215
7006008	110 x 125 (5")	220	180	132	18	10	8	15	1720
7006009	125 / 160 x 150 (5")	220	180	151	18	10	8	15	1416
7006010	125 / 160 x 150 (6")	250	210	151	18	10	8	15	2850

Flange galvanised via electroplating then protected with a proprietary passivation process.

Metric Barrel Union Adaptor with Male Thread

7250

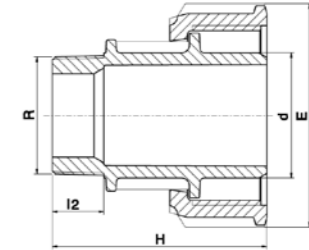

Product Code	Size d x R	E	H	I2	Bag	Carton	W	PN
7250001	25 x 1/2"	54	79	17	1	200	36	16
7250002	25 x 3/4"	54	80	18	1	200	36	16
7250003	32 x 1/2"	64	85	17	1	180	66	16
7250004	32 x 3/4"	64	86	18	1	180	65	16
7250005	32 x 1"	64	87	20	1	180	68	16
7250006	40 x 1"	82	99	20	1	130	108	16
7250007	40 x 1 1/4"	82	100	22	1	130	112	16
7250008	40 x 1 1/2"	82	100	22	1	130	113	16
7250009	50 x 1"	96	102	20	1	80	147	16
7250010	50 x 1 1/4"	96	104	24	1	80	154	16
7250011	50 x 1 1/2"	96	104	24	1	80	156	16
7250012	50 x 2"	96	107	27	1	80	158	16
7250025	63 x 1"	113	108	20	1	60	228	16
7250026	63 x 1 1/4"	113	111	22	1	60	230	16
7250027	63 x 1 1/2"	113	111	22	1	60	230	16
7250028	63 x 2"	113	114	26	1	60	258	16
7250029	63 x 2 1/2"	113	116	29	1	60	250	16
7250030	75 x 1 1/2"	134	128	22	1	30	404	12.5
7250031	75 x 2"	134	132	26	1	30	402	12.5
7250032	75 x 2 1/2"	134	134	29	1	30	412	12.5
7250033	75 x 3"	134	137	33	1	30	430	12.5

Metric Universal Coupling

7017

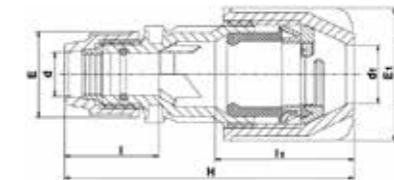

Product Code	Size d (PE) x d1 (Universal)	E	E1	I	I1	H	Bag	Carton	W	PN
7017001	25 x 15 - 22	54	64	58	80	165	1	90	183	16
7017002	25 x 20 - 27	54	71	58	85	170	1	80	216	16
7017003	32 x 20 - 27	54	83	58	90	180	1	60	281	16
7017004	25 x 27 - 35	64	71	67	85	180	1	70	240	16
7017005	32 x 27 - 35	64	83	67	90	195	1	60	312	16
7017006	50 x 35 - 50	96	121	93	125	270	1	20	901	10

Suitable for PE, PVC, PP, PB, Gal and copper pipes with outside diameter that suits the fitting size range.

Metric 90° Universal Elbow

7057



Product Code	Size d x d1	E	E1	I	I1	A	A1	Bag	Carton	W	PN
7057001	25 x 15 - 22	54	64	58	105	81	128	1	80	198	16
7057002	25 x 20 - 27	54	71	58	105	81	139	1	70	238	16
7057003	25 x 27 - 35	54	83	58	112	81	153	1	55	305	16

Suitable for PE, PVC, PP, PB, Gal and copper pipes with outside diameter that suits the fitting size range.

Metric Y Fitting with Threaded Male Offtake

7550



Product Code	Size d x d x R	E	E1	I	I1	I2	A	A1	Bag	Carton	W	PN
7550001	16 x 16 x 3/4"	39	39	50	50	18	100	100	10	200	75	8
7550002	20 x 20 x 3/4"	48	48	57	57	18	114	114	10	120	130	8
7550003	25 x 25 x 3/4"	54	54	58	58	18	125	125	5	100	154	8

Metric Cross with Threaded Female Offtake

7540

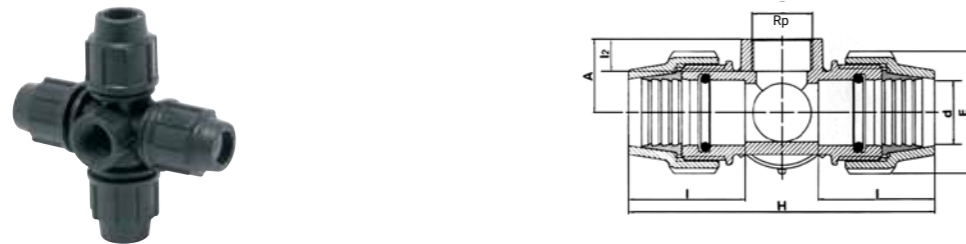

Product Code	Size d x d x d x d x Rp	E	I	I2	H	A	Bag	Carton	W	PN
7540001	20 x 20 x 20 x 20 x 3/4"	48	57	21	149	35	5	80	204	16

Conversion & Adaptor Sets

Metric Plug Adaptor

7120

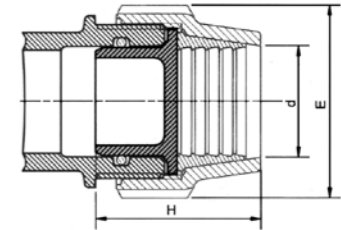

Product Code	Size d	E	H	Bag	Carton	W	PN
7120005	20	48	47	10	2500	5	12.5
7120006	25	54	51	10	1500	8	12.5
7120007	32	64	56	10	1000	15	12.5
7120008	40	82	66	10	720	24	12.5
7120009	50	96	80	10	400	41	12.5
7120024	63	113	96	10	200	76	12.5

Metric Reducing Set

7930

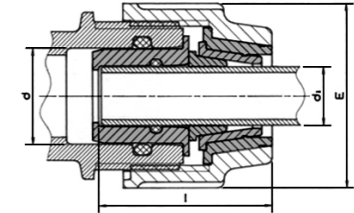

Product Code	Size d x d1	E	I	Bag	Carton	W	PN
7930001	25 x 20	54	56	1	300	22	16
7930002	32 x 20	64	62	1	300	38	16
7930003	32 x 25	64	60	1	250	35	16
7930004	40 x 20	82	73	1	180	62	16
7930005	40 x 25	82	69	1	180	81	16
7930006	40 x 32	82	77	1	200	62	16
7930007	50 x 25	96	85	1	120	114	16
7930008	50 x 32	96	87	1	120	112	16
7930009	50 x 40	96	85	1	120	97	16
7930010	63 x 25	113	103	1	80	217	16
7930011	63 x 32	113	102	1	80	214	16
7930012	63 x 40	113	103	1	80	201	16
7930013	63 x 50	113	105	1	80	187	16
7930014	110 x 63	181	131	1	24	703	16

Only suitable for metric PE fittings and components.

Metric Modular Adaptor

7940

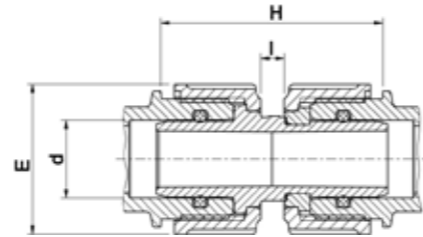

Product Code	Size d	E	H	I	Bag	Carton	W	PN
7940001	20	48	80	10	10	300	50	16
7940002	25	54	80	10	10	250	61	16
7940003	32	64	93	10	5	180	104	16
7940004	40	82	102	10	5	100	173	16
7940005	50	93	107	10	1	70	257	16
7940006	63	113	119	10	1	45	422	16

Metric Copper Pipe Adaptor

7113

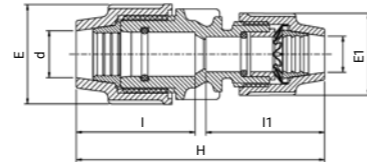

Product Code	Size d (PE) x d1 (Cu)	E	E1	H	I	I1	Bag	Carton	W	PN
7113001	16 x 15 (1/2")	48	39	111	57	50	1	250	85	16
7113002	16 x 20 (3/4")	54	39	113	58	50	1	200	102	16
7113003	20 x 15 (1/2")	48	48	122	59	59	1	200	103	16
7113004	20 x 20 (3/4")	54	48	119	58	57	1	150	120	16
7113005	25 x 15 (1/2")	54	48	119	58	57	1	150	115	16
7113006	25 x 20 (3/4")	54	54	126	61	61	1	150	132	16
7113007	25 x 25 (1")	54	54	126	61	61	1	150	120	16
7113008	32 x 20 (3/4")	64	54	133	67	58	1	120	163	16
7113009	32 x 25 (1")	64	54	133	67	58	1	120	156	16

Metric Poly to Copper Tee

7043

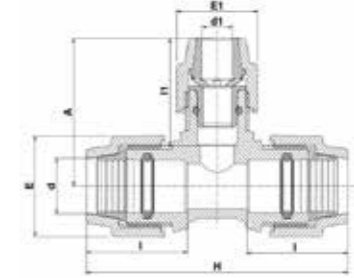

Product Code	Size d (PE) x d1 (Cu)	E	E1	H	I	I1	A	Bag	Carton	W	PN
7043001	20 x 15(1/2")	48	48	145	56	56	73	1	250	85	16
7043002	25 x 15(1/2")	54	48	150	58	57	74	1	200	102	16
7043003	25 x 20(3/4")	54	54	156	58	58	78	1	200	103	16
7043004	25 x 25(1")	54	54	156	58	58	78	1	150	120	16
7043005	32 x 25(1")	64	54	173	67	58	83	1	150	115	16

Note: If the fitting is to be re-used then a new SS split ring must be inserted.

Metric Poly to Copper Elbow

7056

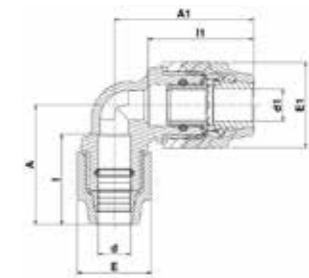

Product Code	Size d (PE) x d1 (Cu)	E	E1	I	I1	A	A1	Bag	Carton	W	PN
7056001	20 x 15(1/2")	48	48	56	56	73	73	1	200	123	16
7056002	20 x 20(3/4")	54	48	58	57	90	75	1	150	123	16
7056003	25 x 15(1/2")	54	48	58	57	90	75	1	150	123	16
7056004	25 x 20(3/4")	54	54	58	58	79	79	1	150	138	16
7056005	25 x 25(1")	54	54	58	58	79	79	1	150	123	16

Note: If the fitting is to be re-used then a new SS split ring must be inserted.

Metric Poly to Copper Stopcock

3408



Product Code	Size d (PE) x d1 (Cu)	E	H	I	A	Bag	Carton	W	PN
3408001	20 x 15(1/2")	48	147	47	87	1	100	160	12.5
3408002	25 x 20(3/4")	54	154	49	87	1	70	160	12.5

Note: If the fitting is to be re-used then a new SS split ring must be inserted.

Metric Plasscom Coupling

1201

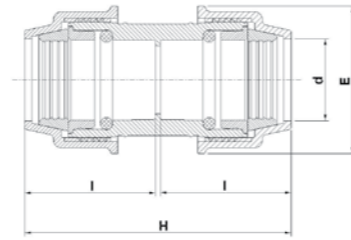

Product Code	Size d	E	H	I	Bag	Carton	W
1201001	20	42	90	44	10	500	37
1201002	25	50	98	48	10	300	56
1201003	32	61	114	56	10	160	99
1201004	40	73	127	62	1	100	150
1201005	50	89	146	74	1	60	245
1201006	63	106	167	82	1	40	400

Metric Poly to Polybutylene Connector

7112



Product Code	Size d (PE) x d1 (PB)	E	E1	H	I	I1	Bag	Carton	W	PN
7112001	25 x 18PB	54	39	113	58	50	10	220	88	16
7112002	25 x 22PB	54	54	126	61	61	10	180	120	16

Metric Poly to Polybutylene Kit

7435



Product Code	Size d (PE) x d1 (PB)	E	I	Bag	Carton	W
7435001	25 x 22PB	54	61	1	350	40

Metric Grip Ring for UPVC and PP Pipe

7970

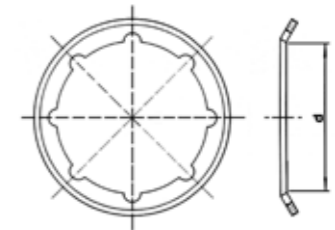

Product Code	Size d	Bag	Carton	W
7970001	20	1	10000	1
7970002	25	1	10000	2
7970003	32	1	10000	3
7970004	40	1	1000	6
7970005	50	1	1000	10
7970006	63	1	1000	17

Metric Conversion Set for Copper Pipe

7439

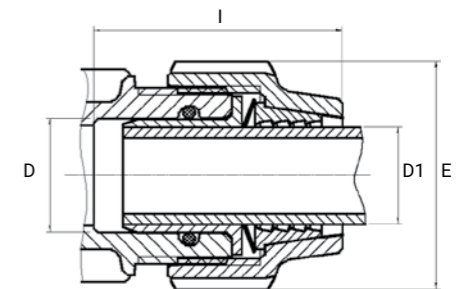

Product Code	Size d x d1	E	I	Bag	Carton	W
7439001	20 x 15 (1/2") (O.D. 12.7mm)	48	67	1	300	42
7439002	25 x 20 (3/4") (O.D. 19.5mm)	54	69	1	250	51
7439003	25 x 25 (1") (O.D. 25.4mm)	54	69	1	250	34

Australian AS1432 Dimensions.

Metric Poly to Series 1 PVC Connector

7016

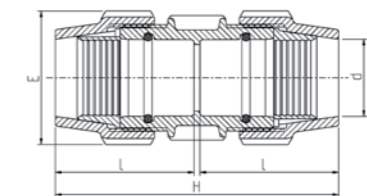

Product Code	Size d x d	E	H	I	Bag	Carton	W	PN
7016001	63PE x 50(2") PVC	134	278	138	1	16	1183	16
7016002	110PE x 100(4") PVC	154	335	165	1	10	1898	16

Accessories for Compression Fittings

Metric O - Rings

7002



Metric Size	Product Code NBR	Product Code EPDM	Product Code Viton FPM
16	7002001	7002013	305003
20	7002002	7002014	7002023
25	7002003	7002015	7002024
32	7002004	7002016	7002025
40	7002005	7002035	7002038
50	7002006	7002036	7002039
63	7002007	7002037	7002040
75	7002008	7002020	7002029
90	7002009	7002021	7002030
110	7002010	7002022	7002031
125	7002011		
160	7002012		

NBR O-Ring supplied as standard in Plasson compression fittings (plain black).
EPDM supplied with blue markings for identification.
Viton FPM supplied with white markings for identification.

Metric Trapeze Rings

7002



Metric Size	Product Code Nitrile NBR	Product Code EPDM	Product Code Viton FPM
40	7002005	7002017	7002026
50	7002006	7002018	7002027
63	7002007	7002019	7002028

NBR Trapeze Ring supplied as standard in Plasson compression fittings (plain black).
EPDM supplied with blue markings for identification.
Viton FPM supplied with white markings for identification.

Metric Split Rings

7003



Metric Size	Product Code Acetal (POM)	Product Code C-PVC
16	7003004	7003015
20	7003005	7003016
25	7003006	7003017
32	7003007	7003018
40	7003008	7003019
50	7003009	7003020
63	7003010	7003021
75	7003011	7003022
90	7003012	7003023
110	7003013	7003024
125	7003014	

Metric Nut

7004

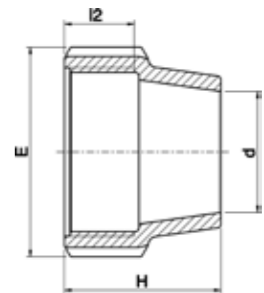

Product Code	Lilac Product Code	Size d	E	H	I2	Bag	Carton	W
7004001	-	16	39	40	23	10	1000	12
7004002	7004012	20	48	45	26	10	700	22
7004003	7004013	25	54	46	26	10	500	26
7004004	7004014	32	64	51	30	5	300	41
7004005	7004015	40	82	63	34	1	200	70
7004006	7004016	50	96	71	34	1	125	104
7004007	7004017	63	113	89	43	1	100	171
7004008	-	75	132	110	56	1	64	279
7004009	-	90	152	135	73	1	36	435
7004010	-	110	181	170	97	1	16	752
7004011	-	125	212	185	107	1	10	1135

Metric Insert

7005



Product Code	Size d	H	W
7005006	75	17	31
7005007	90	25	56
7005008	110	30	81
7005009	125 Upper	48	153
7005010	125 Lower	18	204

Metric Chamfer Tool for PE Pipes

7960



Product Code	Size	Bag	Carton	W
7960003	20 - 63	1	64	202

Metric Wrench

7990



Product Code	Size	Material	Bag	Carton	W
7990006	16 - 40	Polymer	1	250	65
7990007	40 - 75	Alloy	1	75	296
7990008	63 - 125	Alloy	1	40	840

Fittings for 160mm Pipes

Metric Coupling

7010

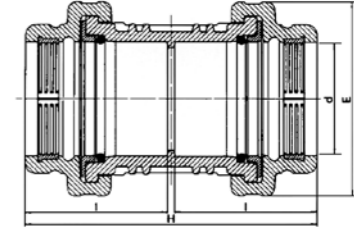

Product Code	Size d x d	E	I	H	Bag	Carton	W	PN
7010023	160 x 160	280	204	418	1	2	8888	10

Metric Repair Coupling

7610

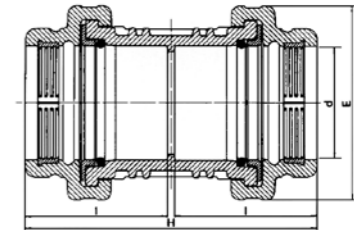

Product Code	Size d x d	E	I	H	Bag	Carton	W	PN
7610011	160 x 160	280	204	418	1	2	9170	10

Metric 90° Tee

7040

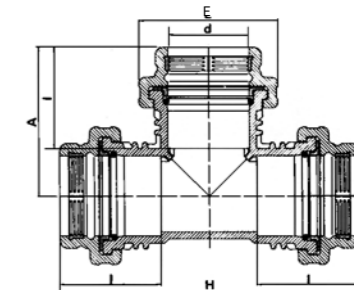

Product Code	Size d x d x d	E	I	H	A	Bag	Carton	W	PN
7040016	160 x 160 x 160	280	204	601	301	1	1	14738	10

Metric 90° Elbow

7050



Product Code	Size d x d	E	I	A	Bag	Carton	W	PN
7050016	160 x 160	280	204	301	1	2	10008	10

Metric Shouldered Adaptor

7320



Product Code	Size d x DN (inch)	E	H	I	L	B	Bag	Carton	W	PN
7320004	160 x 150 (6")	280	304	204	18	175	1	4	5170	10

Metric Compression Flange Adaptor (with Metal Flange)

7220



Product Code	Metric x ISO Flange	E	H	I	D	Dp	S	No. of Holes	Carton	W	PN
7220009	160 x 125 (5")	280	304	204	250	210	18	8	3	7700	10
7220010	160 x 150 (6")	280	304	204	285	240	22	8	3	9151	10

Flange galvanised via electroplating then protected with a proprietary passivation process.

Metric Half Metal Flange

7006

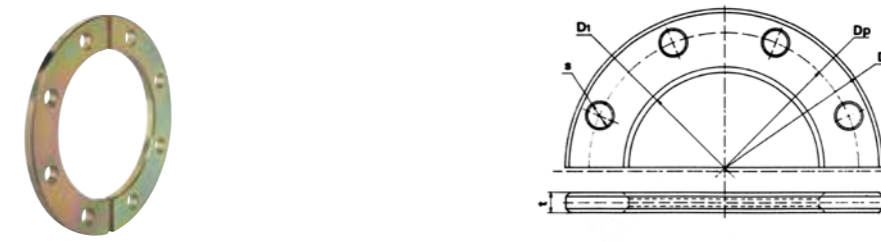

Product Code	Metric x ISO Flange	D	Dp	D1	S	t	No. of Holes	W
7006009	125 / 160 x 125 (5")	250	210	170	18	12	8	1100
7006010	125 / 160 x 150 (6")	250	240	170	22	12	8	1800

Flange galvanised via electroplating then protected with a proprietary passivation process.

Metric Flange Adaptor (with Metal Flange)

7230



Product Code	Metric x ISO Flange	H	D	Dp	S	No. of Holes	Carton	W	PN
7230011	160 x 125 (5")	265	250	210	18	8	6	4345	10
7230012	160 x 150 (6")	265	285	240	22	8	5	5650	10

Flange galvanised via electroplating then protected with a proprietary passivation process.

Mine Fittings

Metric Mine - Coupling

7015

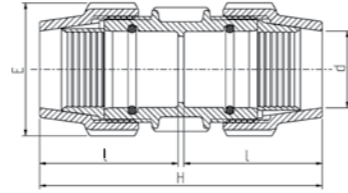

Product Code	Size d x d	E	H	I	Bag	Carton	W	PN
7015001	63 x 63	113	230	113	1	30	741	16

Metric Mine - Repair Coupling

7615

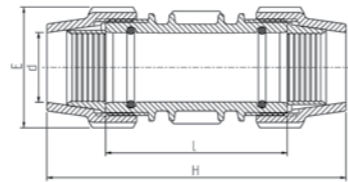

Product Code	Size d x d	E	H	I	Bag	Carton	W	PN
7615001	63 x 63	113	270	170	1	24	836	16

Metric Mine - Reducing Coupling

7115

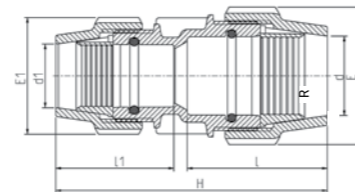

Product Code	Size d x d1	E	E1	H	I	I1	Bag	Carton	W	PN
7115001	63 x 25	113	54	193	110	58	1	50	461	16
7115002	63 x 32	113	64	197	110	62	1	45	486	16
7115003	63 x 40	113	82	208	110	82	1	40	546	16
7115004	63 x 50	113	96	214	110	93	1	36	574	16
7115005	90 x 63	154	113	292	170	115	1	14	1415	16
7110029	110 x 63	181	181	393	194	131	1	5	3695	16

Metric Mine - Male Adaptor

7025

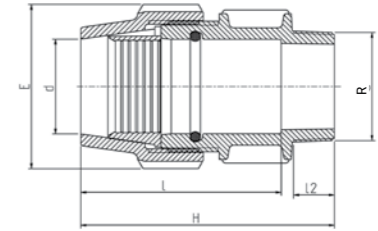

Product Code	Size d x R	E	H	I	I2	Bag	Carton	W	PN
7025001	63 x 1 1/4"	113	154	123	22	1	48	443	16
7025002	63 x 1 1/2"	113	154	123	22	1	48	451	16
7025003	63 x 2"	113	167	123	26	1	48	461	16
7025004	63 x 2 1/2"	113	160	123	29	1	45	459	16

Metric Mine - Female Adaptor

7035

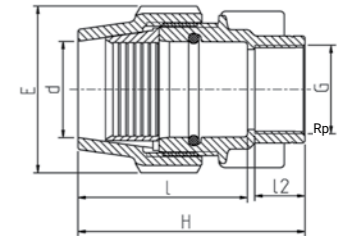

Product Code	Size d x Rp	E	H	I	I2	Bag	Carton	W	PN
7035001	63 x 1 1/4"	113	139	110	25	1	48	417	16
7035002	63 x 1 1/2"	113	139	110	25	1	48	438	16
7035003	63 x 2"	113	148	110	30	1	48	443	16

Metric Mine - Shouldered Adaptor

7325

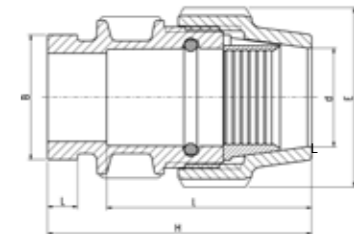

Product Code	Size d x DN (inch)	E	I	L	H	B	Bag	Carton	W	PN
7325001	63 x 50 (2")	113	123	16	156	67	1	45	437	16

Metric Mine - 90° Elbow

7055



Product Code	Size d x d	E	I	A	Bag	Carton	W	PN
7055001	63 x 63	113	110	151	1	24	838	16

Metric Mine - 45° Elbow

7065



Product Code	Size d x d	E	I	A	Bag	Carton	W	PN
7065005	63 x 63	113	110	130	1	24	772	16

Metric Mine - 90° Elbow with Threaded Male Offtake

7855



Product Code	Size d x R	E	I	I2	A	A1	Bag	Carton	W	PN
7855001	63 x 1 1/4"	113	110	22	168	76	1	35	451	16
7855002	63 x 1 1/2"	113	110	22	168	76	1	35	468	16
7855003	63 x 2"	113	110	26	170	92	1	35	518	16

Metric Mine - 90° Tee

7045

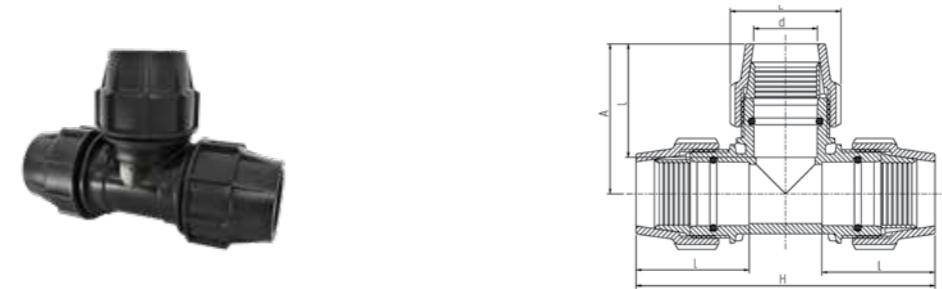

Product Code	Size d x d x d	E	H	I	A	Bag	Carton	W	PN
7045001	63 x 63 x 63	113	294	110	146	1	16	1215	16

Metric Mine - 90° Elbow with Threaded Female Offtake

7155

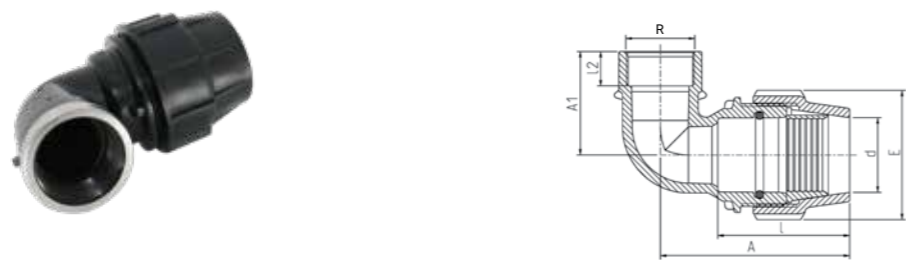

Product Code	Size d x Rp	E	I	I2	A	A1	Bag	Carton	W	PN
7155001	63 x 1 1/4"	113	110	25	162	65	1	35	488	16
7155002	63 x 1 1/2"	113	110	25	162	69	1	35	504	16
7155003	63 x 2"	113	110	30	160	90	1	35	559	16

Metric Mine - 90° Slip Tee

7046

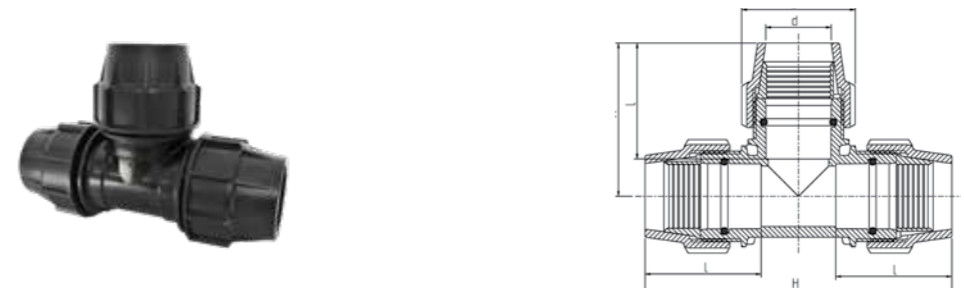

Product Code	Size d x d x d	E	H	I	A	Bag	Carton	W	PN
7046007	63 x 63 x 63	113	294	110	146	1	16	1107	12.5

Metric Mine - 90° Reducing Tee

7345

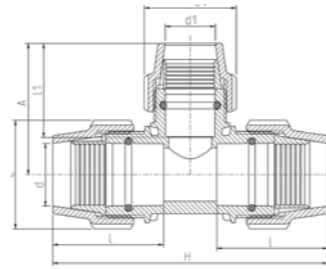

Product Code	Size d x d1 x d	E	E1	H	I	I1	A	Bag	Carton	W	PN
7345001	63 x 32 x 63	113	64	268	113	62	118	1	20	892	16
7345002	63 x 40 x 63	113	82	268	113	84	139	1	20	962	16
7345003	63 x 50 x 63	113	96	275	110	93	132	1	18	1021	16

Metric Mine - 90° Tee with Threaded Male Offtake

7845

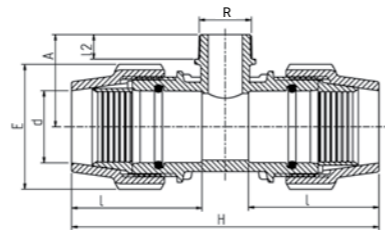

Product Code	Size d x R x d	E	H	I	I2	A	Bag	Carton	W	PN
7845001	63 x 1 1/4" x 63	113	268	113	22	79	1	20	821	16
7845002	63 x 1 1/2" x 63	113	268	113	22	83	1	20	828	16
7845003	63 x 2" x 63	113	272	110	26	92	1	20	877	16

90° Tee with Threaded Female Offtake

7145

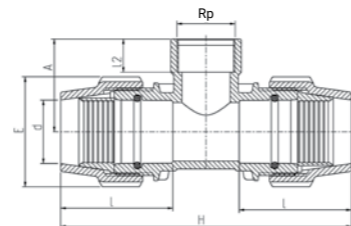

Product Code	Size d x Rp x d	E	H	I	I2	A	Bag	Carton	W	PN
7145001	63 x 1 1/4" x 63	113	268	113	27	95	1	20	886	16
7145002	63 x 1 1/2" x 63	113	268	113	27	95	1	20	898	16
7145003	63 x 2" x 63	113	272	110	30	95	1	20	903	16

Metric Mine - End Plug

7125

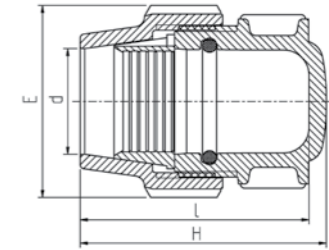

Product Code	Size d	E	I	H	Bag	Carton	W	PN
7125001	63	113	122	145	1	45	448	16

Metric Mine - Flange Coupling

7225

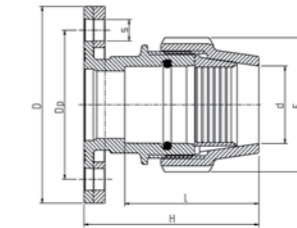

Product Code	Size d x ISO Flange	E	H	I	D	Dp	S	No of Holes	Carton	W	PN
7225001	63 x 50 (2")	113	145	110	165	125	18	4	015	1563	16

Flange galvanised via electroplating then protected with a proprietary passivation process.

Metric Mine - Reducing Set

7930

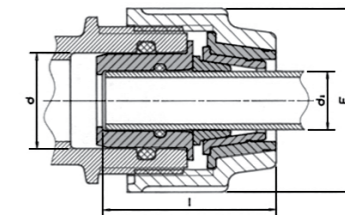

Product Code	Size d x d1	E	I	Bag	Carton	W	PN
7930010	63 x 25	113	103	1	80	217	16
7930011	63 x 32	113	102	1	80	214	16
7930012	63 x 40	113	103	1	80	201	16
7930013	63 x 50	113	105	1	80	187	16
7930014	110 x 63	181	131	1	24	703	16

Mine Spray Nozzle

7120

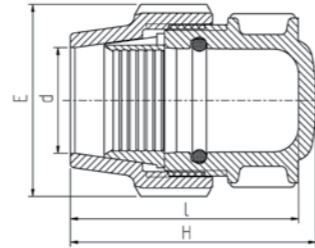

Product Code	Suits Pipe	E	I	H	Bag	Carton	W	PN
7120101	Rural 1"	54	77	90	10	200	78	10
7120102	Rural 1 1/4"	64	87	100	5	180	128	10
7120103	Rural 1 1/2"	82	97	120	1	100	218	10
7120104	Metric 25	54	77	82	10	250	70	16
7120105	Metric 32	64	87	92	5	180	106	16
7120106	Metric 40	82	97	102	1	110	184	16

Suitable for use as spray nozzle for dust suppression. Spray pattern is large droplet though largely determined by system pressure.

FIXED RATIO PRESSURE REDUCING VALVE

Designed to reduce static head pressure, especially in underground mining water supply systems.



Features and Benefits:

- ✓ Lightweight (approx. 15kg) for fast and easy installation
- ✓ Stable pressure control over the full flow and pressure range
- ✓ Corrosion resistant plastic body and internal parts
- ✓ Long service life even in abrasive fluids (sand, stones) due to an innovative hydraulic design and sealed moving components
- ✓ Assembled directly to PE pipe with integral Plasson compression fittings
- ✓ Can be installed either vertically or horizontally
- ✓ Maintenance free
- ✓ Unbox & install

CODE	DESCRIPTION
3801001	FIXED RATIO PRESSURE REDUCING VALVE METRIC 63 RATIO 2:1
3801002	FIXED RATIO PRESSURE REDUCING VALVE METRIC 63 RATIO 3:1
3801003	FIXED RATIO PRESSURE REDUCING VALVE METRIC 110 RATIO 2:1
3801004	FIXED RATIO PRESSURE REDUCING VALVE METRIC 110 RATIO 3:1

Technical Specifications:

- ✓ Pressure rating: 16 bar
- ✓ Working pressure range: 2-16 bar
- ✓ Flow range - 63mm: 0-14m³/hour with capacity of 30m³/hour, 110mm: nominal 55m³/hour, maximum 80m³/hour
- ✓ Body: Polypropylene PPB
- ✓ Seals: NBR
- ✓ Diaphragm: Reinforced Neoprene
- ✓ Available in pressure reduction ratios - 2:1 or 3:1
- ✓ Connections: Plasson metric mine safe fittings 63 OD & 110 OD
- ✓ Optional: Threaded male BSP (63 OD) and shouldered (110 OD on request)







PLASSON

TAPPING SADDLES

Tapping Saddles

- 1602**

Page 83 Rural Tapping Saddle 
- 1607**

Page 84 Tapping Saddle for Metric and Rural (Long Bolts) 
- 1607**

Page 85 Metric Tapping Saddle with Galvanised Bolts 
- 1607**

Page 86 Metric Tapping Saddle Single With S/S Bolts 
- 1601**

Page 87 Spare Bolt Kits 
- 1601**

Page 87 Spare O - Rings 
- 1630**

Page 89 Plassaddle for PE Pipe - Threaded 
- 1631**

Page 90 Plassaddle Tapper for PE Pipe - PE Compression Outlet 
- 1631**

Page 90 Plassaddle Tapper for PE Pipe - Copper Compression Outlet 

- 1631**

Page 91 Plassaddle Tapper for PE Pipe - Male Threaded Outlet 
- 1630**

Page 91 Plassaddle for Series 2 PVC Pipe AS1477 - Threaded Outlet 
- 1631**

Page 92 Plassaddle Tapper for Series 2 PVC Pipe AS1477 - PE Compression Outlet 
- 1631**

Page 92 Plassaddle Tapper for Series 2 PVC AS1477 - Male Threaded Outlet 
- 1631**

Page 93 Plassaddle Tapper for Series 2 PVC AS1477 - Copper Compression Outlet 
- 2013**

Page 93 Hex Key 

Saddle Pipe Size Selection

Pipe Type	Nominal Saddle Size											
	20	25	32	40	50	63	75	90	110	125	140	160
Metric Poly	20	25	32	40	50	63	75	90	110	125	140	160
Rural Poly	19 (3/4")	25 (1")	32 (1.1/4")	40 (1.1/2")	50 (2")	-	-	-	-	-	-	-
PVC AS1477	15	20	25	32	40	50	65	80	100	-	125	150

Saddle Pressure Ratings

Pipe Size (mm)	Polyethylene Metric Pipe BSP Outlet Size						Polyethylene Rural Pipe	PVC Pressure AS1477 PIPE
	1/2"	3/4"	1"	1.1/4"	1.1/2"	2"		
20-50	12.5	12.5	12.5	12.5	-	-	All PN10	All PN9 except 40-50mm=PN6.3
63	16	16	12.5	12.5	12.5	-		
75-180	12.5	12.5	10	10	10	10		

Rural Tapping Saddle

1602

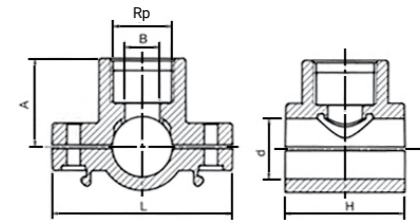

Galvanised Bolts									
Product Code	Size d x Rp	B	L	H	A	Bag	Carton	W	
1607010	2" x 1/2"	10	106	73	40	1	100	175	
1602001	2" x 3/4"	21	106	73	52	1	100	179	
1602002	2" x 1"	25	106	73	54	1	100	186	

Stainless Steel Bolts									
Product Code	Size d x Rp	B	L	H	A	Bag	Carton	W	
1607118	2" x 1/2"	10	106	73	40	1	100	175	
1602003	2" x 3/4"	21	106	73	52	1	100	179	
1602004	2" x 1"	25	106	73	54	1	100	186	

Bolts galvanised via electroplating then protected with a proprietary passivation process.

Tapping Saddle for Metric & Rural (Long Bolts)

1607

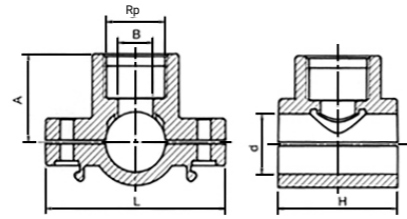

Galvanised Bolts										
Product Code	Metric (Rural) d x Rp	B	L	L1	A	No. of Bolts	Bag	Carton	W	PN
1607001	20 (3/4") x 1/2"	10	70	45	33	2	1	400	62	12.5
1607002	25 (1") x 1/2"	15	75	50	36	2	1	300	70	12.5
1607003	25 (1") x 3/4"	15	75	50	37	2	1	300	70	12.5
1607004	32 (1.1/4") x 1/2"	16	92	60	40	2	1	150	133	12.5
1607005	32 (1.1/4") x 3/4"	19	92	60	41	2	1	150	134	12.5
1607006	32 (1.1/4") x 1"	20	92	60	42	2	1	150	142	12.5
1607007	40 (1.1/2") x 1/2"	16	92	60	40	2	1	150	149	12.5
1607008	40 (1.1/2") x 3/4"	19	92	60	46	2	1	150	142	12.5
1607009	40 (1.1/2") x 1"	25	92	60	49	2	1	150	150	12.5
1607010	50 (2") x 1/2"	10	106	73	73	2	1	100	175	12.5
1607011	50 (2") x 1.1/4"	25	106	73	58	2	1	100	211	12.5

Stainless Steel Bolts										
Product Code	Metric (Rural) d x Rp	B	L	L1	A	No. of Bolts	Bag	Carton	W	PN
1607109	20 (3/4") x 1/2"	10	70	45	33	2	1	400	62	12.5
1607110	25 (1") x 1/2"	15	75	50	36	2	1	300	70	12.5
1607111	25 (1") x 3/4"	15	75	50	37	2	1	300	70	12.5
1607112	32 (1.1/4") x 1/2"	16	92	60	40	2	1	150	133	12.5
1607113	32 (1.1/4") x 3/4"	19	92	60	41	2	1	150	134	12.5
1607114	32 (1.1/4") x 1"	20	92	60	42	2	1	150	142	12.5
1607115	40 (1.1/2") x 1/2"	16	92	60	40	2	1	150	149	12.5
1607116	40 (1.1/2") x 3/4"	19	92	60	46	2	1	150	142	12.5
1607117	40 (1.1/2") x 1"	25	92	60	49	2	1	150	150	12.5
1607119	50 (2") x 1.1/4"	25	106	73	58	2	1	100	211	12.5

Bolts galvanised via electroplating then protected with a proprietary passivation process.

Metric Tapping Saddle with Galvanised Bolts

1607

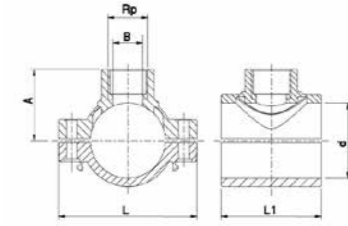

Galvanised Bolts										
Product Code	Size d x Rp	B	L	L1	A	No. of Bolts	Bag	Carton	W	PN
1607012	50 x 3/4"	21	106	73	52	2	1	100	180	12.5
1607013	50 x 1"	25	106	73	54	2	1	100	187	12.5
1607014	50 x 1 1/4"	25	106	73	58	2	1	100	212	12.5
1607015	63 x 1/2"	16	116	84	58	4	1	70	278	16
1607016	63 x 3/4"	20	116	84	59	4	1	70	279	16
1607017	63 x 1"	25	116	84	61	4	1	70	286	12.5
1607018	63 x 1 1/4"	32	116	84	66	4	1	70	308	12.5
1607019	63 x 1 1/2"	39	116	84	67	4	1	60	322	12.5
1607020	75 x 1/2"	16	122	98	64	4	1	60	369	12.5
1607021	75 x 3/4"	20	122	98	65	4	1	55	369	12.5
1607022	75 x 1"	25	122	98	67	4	1	55	376	10
1607023	75 x 1 1/4"	32	122	98	72	4	1	55	398	10
1607024	75 x 1 1/2"	40	122	98	73	4	1	50	411	10
1607025	75 x 2"	40	122	98	78	4	1	50	433	10
1607026	90 x 1/2"	16	141	105	72	4	1	45	453	12.5
1607027	90 x 3/4"	20	141	105	73	4	1	45	454	12.5
1607028	90 x 1"	25	141	105	75	4	1	45	460	10
1607029	90 x 1 1/4"	32	141	105	80	4	1	40	483	10
1607030	90 x 1 1/2"	40	141	105	81	4	1	40	467	10
1607031	90 x 2"	50	141	105	86	4	1	40	511	10
1607032	110 x 1/2"	16	165	116	83	4	1	45	561	12.5
1607033	110 x 3/4"	20	165	116	84	4	1	45	562	12.5
1607034	110 x 1"	25	165	116	87	4	1	36	567	10
1607035	110 x 1 1/4"	32	165	116	91	4	1	36	588	10
1607036	110 x 1 1/2"	40	165	116	92	4	1	36	600	10
1607037	110 x 2"	50	165	116	97	4	1	30	615	10
1607038	125 x 3/4"	20	184	124	91	6	1	30	762	12.5
1607039	125 x 1"	25	184	124	94	6	1	30	755	10
1607040	125 x 1 1/4"	32	184	124	98	6	1	30	778	10
1607041	125 x 1 1/2"	40	184	124	99	6	1	30	781	10
1607042	125 x 2"	50	184	124	104	6	1	25	796	10
1607043	140 x 1"	25	201	136	101	6	1	24	893	10
1607044	140 x 1 1/4"	32	201	136	106	6	1	24	912	10
1607045	140 x 1 1/2"	40	201	136	107	6	1	24	922	10
1607046	140 x 2"	50	201	136	112	6	1	20	938	10
1607047	160 x 1"	25	223	145	112	6	1	20	1039	10
1607048	160 x 1 1/4"	32	223	145	117	6	1	20	1061	10
1607049	160 x 1 1/2"	40	223	145	118	6	1	20	1071	10
1607050	160 x 2"	50	223	145	123	6	1	20	1080	10
1607051	180 x 1"	25	245	154	122	6	1	16	1314	10
1607052	180 x 1 1/4"	32	245	154	127	6	1	16	1319	10
1607053	180 x 1 1/2"	40	245	154	128	6	1	16	1349	10
1607054	180 x 2"	50	245	154	133	6	1	16	1334	10

The nuts and bolts are made of galvanised steel. O-Rings are NBR rubber.
 FPM and EPDM O-Rings are available subject to special pricing and delivery.
 Bolts galvanised via electroplating then protected with a proprietary passivation process.
 For buried applications, use SS nuts & bolts.

Metric Tapping Saddle Single With S/S Bolts

1607

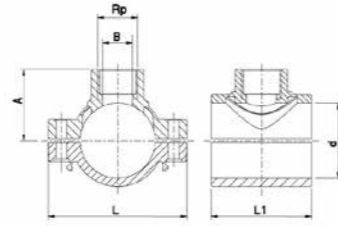

Stainless Steel Bolts

Product Code	Size d x Rp	B	L	L1	A	No. of Bolts	Bag	Carton	W	PN
1607055	20 x 1/2"	10	70	45	33	2	1	400	62	12.5
1607056	25 x 1/2"	15	75	50	36	2	1	300	70	12.5
1607057	25 x 3/4"	15	75	50	37	2	1	300	70	12.5
1607058	32 x 1/2"	16	92	60	40	2	1	150	133	12.5
1607059	32 x 3/4"	19	92	60	41	2	1	150	134	12.5
1607060	32 x 1"	20	92	60	42	2	1	150	142	12.5
1607061	40 x 1/2"	16	92	60	45	2	1	150	142	12.5
1607062	40 x 3/4"	19	92	60	46	2	1	150	142	12.5
1607063	40 x 1"	25	92	60	49	2	1	150	150	12.5
1607064	50 x 1/2"	16	106	73	51	2	1	100	178	12.5
1607065	50 x 3/4"	21	106	73	52	2	1	100	179	12.5
1607066	50 x 1"	25	106	73	54	2	1	100	186	12.5
1607067	50 x 1.1/4"	25	106	73	58	2	1	100	211	12.5
1607068	63 x 1/2"	16	116	84	58	4	1	70	277	16
1607069	63 x 3/4"	20	116	84	59	4	1	70	279	16
1607070	63 x 1"	25	116	84	61	4	1	70	292	12.5
1607071	63 x 1.1/4"	32	116	84	66	4	1	70	307	12.5
1607072	63 x 1.1/2"	39	116	84	67	4	1	60	321	12.5
1607073	75 x 1/2"	16	122	98	64	4	1	60	279	12.5
1607074	75 x 3/4"	20	122	98	65	4	1	55	369	12.5
1607075	75 x 1"	25	122	98	67	4	1	55	375	10
1607076	75 x 1.1/4"	32	122	98	72	4	1	55	397	10
1607077	75 x 1.1/2"	40	122	98	73	4	1	50	409	10
1607078	75 x 2"	40	122	98	78	4	1	45	432	10
1607079	90 x 1/2"	16	141	105	72	4	1	40	460	12.5
1607080	90 x 3/4"	20	141	105	73	4	1	40	453	12.5
1607081	90 x 1"	25	141	105	75	4	1	40	460	10
1607082	90 x 1.1/4"	32	141	105	80	4	1	40	481	10
1607083	90 x 1.1/2"	40	141	105	81	4	1	40	493	10
1607084	90 x 2"	50	141	105	86	4	1	40	510	10
1607085	110 x 1/2"	16	165	116	83	4	1	45	560	12.5
1607086	110 x 3/4"	20	165	116	84	4	1	38	561	12.5
1607087	110 x 1"	25	165	116	87	4	1	36	566	10
1607088	110 x 1.1/4"	32	165	116	91	4	1	36	587	10
1607089	110 x 1.1/2"	40	165	116	92	4	1	36	600	10
1607090	110 x 2"	50	165	116	97	4	1	30	615	10
1607091	125 x 3/4"	20	184	124	91	6	1	30	748	12.5
1607092	125 x 1"	25	184	124	94	6	1	30	754	10
1607093	125 x 1.1/4"	32	184	124	98	6	1	30	777	10
1607094	125 x 1.1/2"	40	184	124	99	6	1	30	781	10
1607095	125 x 2"	50	184	124	104	6	1	25	796	10
1607107	140 x 1"	25	201	136	101	6	1	24	893	10
1607096	140 x 1.1/4"	32	201	136	106	6	1	24	912	10
1607097	140 x 1.1/2"	40	201	136	107	6	1	24	922	10
1607098	140 x 2"	50	201	136	112	6	1	20	959	10
1607099	160 x 1"	25	223	145	112	6	1	20	1071	10
1607100	160 x 1.1/4"	32	223	145	117	6	1	20	1061	10
1607101	160 x 1.1/2"	40	223	145	118	6	1	20	1071	10
1607102	160 x 2"	50	223	145	123	6	1	20	1080	10
1607103	180 x 1"	25	245	154	122	6	1	16	1299	10
1607104	180 x 1.1/4"	32	245	154	127	6	1	16	1337	10
1607105	180 x 1.1/2"	40	245	154	128	6	1	16	1327	10
1607106	180 x 2"	50	245	154	133	6	1	16	1333	10

The nuts and bolts are made of stainless steel. The O-Rings of NBR rubber. O-Rings can be supplied as can FPM and EPDM, but are subject to special pricing and delivery.

Spare Bolt Kits

1601



Product Code	Bolts Dimensions x length	Metric Saddle Size	Rural Saddle Size	Bag
1601001	M6 x 30mm	20 - 25	3/4" - 1"	2
1601002	M8 x 45mm	32 - 40 - 50 - 63	-	2
1601002*	M8 x 45mm	63	-	2
1601003	M8 x 60mm	75 - 90 - 110	1.1/4" x 1.1/2"	4
1601004	M8 x 70mm	125 - 140 - 160 - 180	2"	6

*2x 1601002 kits required for size 63 saddle.

Spare O-Rings

1601

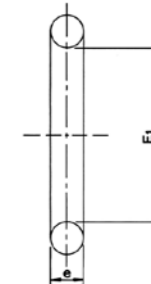

Product Code	O-Ring Size	Suits Saddle Size
7002041	13.95 x 2.62	20 x 1/2"
7002042	18.72 x 2.62	25x1/2", 25x3/4"
7002043	25.80 x 3.53	32x1/2", 32x3/4", 32x1"
7002003	24.00 x 4.00	40x1/2", 40x3/4"
7002004	31.00 x 5.00	40x1", 50x1/2", 50x3/4", 50x1", 50x1.1/4", 63x1/2", 63x3/4", 63x1", 75x1/2", 75x3/4", 75x1", 90x1/2", 90x3/4", 90x1", 110x1/2", 110x3/4", 110x1", 125x3/4", 125x1", 140x1", 160x1", 180x1" 125 - 140 - 160 - 180
7002005	39.00 x 6.00	63x1.1/4", 75x1.1/4", 90x1.1/4", 110x1.1/4", 125x1.1/4", 140x1.1/4", 160x1.1/4", 180x1.1/4"
7002006	49.00 x 7.00	63x1.1/2", 75x1.1/2", 75x2", 90x1.1/2", 110x1.1/2", 125x1.1/2", 140x1.1/2", 160x1.1/4", 180x1.1/2"
7002007	62.00 x 7.00	90x2", 110x2", 125x2", 140x2", 160x2", 180x2"

Some of these O-Rings can be swapped out with EPDM or FPM. See O-Rings in Metric Section.

Plassaddle for PE Pipe - Threaded

1630



PLASSADLE

PLASSON IS PROUD TO INTRODUCE ITS REVOLUTIONARY MECHANICAL SADDLE.

Featuring a fast, bolt-free installation along with our well-established mechanical fitting features.

- Fast and Innovative tightening mechanism.
- No bolts.
- Non-corrosive, strong, plastic parts, no metal components.
- Integral seals - no need for thread sealants.

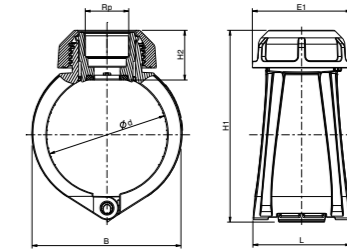

Product Code	Size d x Rp	B	L	E1	H1	H2	Bag	Carton	W	PN
1630001	63 x 1/2"	91	89	102	136	49	1	50	383	16
1630002	63 x 3/4"	91	89	102	136	49	1	50	384	16
1630003	63 x 1"	91	89	102	136	49	1	50	387	16
1630004	63 x 1.1/4"	91	89	102	146	58	1	50	390	16
1630005	63 x 1.1/2"	91	89	102	136	49	1	50	373	16
1630046	75 x 1/2"	99	90	102	148	49	1	50	419	16
1630047	75 x 3/4"	99	90	102	148	49	1	50	421	16
1630048	75 x 1"	99	90	102	148	49	1	50	425	16
1630049	75 x 1.1/4"	99	90	102	157	58	1	50	426	16
1630050	75 x 1.1/2"	99	90	102	148	49	1	50	409	16
1630006	90 x 1/2"	91	94	102	163	49	1	50	455	16
1630007	90 x 3/4"	119	94	102	163	49	1	50	458	16
1630008	90 x 1"	119	94	102	163	49	1	50	464	16
1630009	90 x 1.1/4"	119	94	102	173	58	1	50	462	16
1630010	90 x 1.1/2"	119	94	102	163	49	1	50	446	16
1630011	110 x 1/2"	141	97	102	180	49	1	40	501	16
1630012	110 x 3/4"	119	97	102	180	49	1	40	502	16
1630013	110 x 1"	141	97	102	180	49	1	40	505	16
1630014	110 x 1.1/4"	141	97	102	190	58	1	40	502	16
1630015	110 x 1.1/2"	119	97	102	180	49	1	40	488	16
1630021	125 x 1/2"	157	100	102	198	49	1	36	566	16
1630022	125 x 3/4"	157	100	102	198	49	1	36	567	16
1630023	125 x 1"	157	100	102	198	49	1	36	570	16
1630024	125 x 1.1/4"	157	100	102	207	58	1	36	567	16
1630040	125 x 1.1/2"	157	100	102	198	49	1	36	553	16
1630025	160 x 1/2"	197	106	102	235	49	1	28	731	16
1630026	160 x 3/4"	197	106	102	235	49	1	28	762	16
1630027	160 x 1"	197	106	102	235	49	1	28	765	16
1630028	160 x 1.1/4"	197	106	102	235	58	1	28	713	16
1630029	160 x 1.1/2"	197	106	102	235	49	1	28	690	16
1630035	180 x 1/2"	220	110	102	255	49	1	24	813	16
1630036	180 x 3/4"	220	110	102	255	49	1	24	814	16
1630037	180 x 1"	220	110	102	255	49	1	24	817	16
1630038	180 x 1.1/4"	220	110	102	264	58	1	24	833	16
1630039	180 x 1.1/2"	220	110	102	255	49	1	24	802	16
1630041	200 x 1/2"	246	115	102	265	49	1	16	1100	16
1630042	200 x 3/4"	246	115	102	265	49	1	16	1100	16
1630043	200 x 1"	246	115	102	265	49	1	16	1100	16
1630044	200 x 1.1/4"	246	115	102	265	58	1	16	1110	16
1630045	200 x 1.1/2"	246	115	102	265	49	1	16	1090	16

Plassaddle Tapper for PE Pipe - PE Compression Outlet 1631

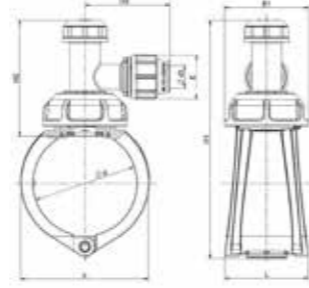

Product Code	Size d x Rp	B	L	E1	H1	H2	H3	Bag	Carton	W	PN
1631001	63 x 25	91	89	102	231	144	106	1	30	642	16
1631002	63 x 32	91	89	102	231	144	111	1	30	677	16
1631055	75 x 25	99	90	102	148	144	106	1	25	674	16
1631056	75 x 32	99	90	102	148	144	111	1	25	704	16
1631003	90 x 25	119	94	102	258	144	106	1	25	717	16
1631004	90 x 32	119	94	102	258	144	111	1	25	748	16
1631005	110 x 25	141	97	102	273	144	106	1	25	764	16
1631006	110 x 32	141	97	102	273	144	111	1	25	795	16
1631009	125 x 25	157	100	64	290	144	106	1	24	820	16
1631010	125 x 32	157	100	64	290	144	111	1	16	859	16
1631011	160 x 25	198	106	102	325	144	106	1	20	968	16
1631012	160 x 32	198	106	102	325	144	111	1	20	1000	16
1631015	180 x 25	220	110	102	350	144	106	1	16	1072	16
1631016	180 x 32	220	110	102	350	144	111	1	16	1102	16
1631049	200 x 25	144	144	115	368	144	106	1	12	1182	16
1631050	200 x 32	144	144	115	368	144	111	1	12	1212	16

Plassaddle Tapper for PE Pipe - Male Threaded Outlet 1631



1" Style

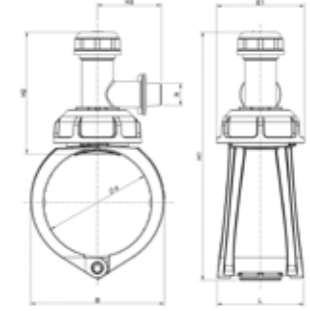

Product Code	Size d x R	B	L	E1	H1	H2	H3	Bag	Carton	W	PN
1631017	63 x 3/4"	91	89	102	231	144	131	1	30	682	16
1631037	63 x 1"	91	89	102	231	144	78	1	30	642	16
1631057	75 x 3/4"	99	90	102	148	144	131	1	30	702	16
1631058	75 x 1"	99	90	102	148	144	78	1	30	660	16
1631018	90 x 3/4"	119	94	102	258	144	131	1	30	720	16
1631038	90 x 1"	119	94	102	258	144	78	1	30	680	16
1631019	110 x 3/4"	141	97	102	273	144	131	1	25	766	16
1631039	110 x 1"	141	97	102	273	144	78	1	25	726	16
1631021	125 x 3/4"	157	100	102	290	144	131	1	25	832	16
1631041	125 x 1"	157	100	102	290	144	78	1	25	792	16
1631022	160 x 3/4"	198	106	102	325	144	131	1	20	972	16
1631042	160 x 1"	198	106	102	325	144	78	1	20	932	16
1631024	180 x 3/4"	220	110	102	350	144	131	1	20	1073	16
1631044	180 x 1"	220	110	102	350	144	78	1	20	1033	16
1631051	200 x 3/4"	246	144	115	368	144	131	1	16	1253	16
1631052	200 x 1"	246	144	115	368	144	78	1	16	1213	16

Plassaddle Tapper for PE Pipe - Copper Compression Outlet 1631

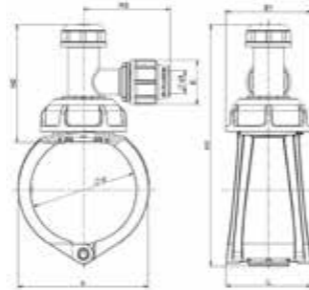

Product Code	Size d x d1	B	L	E1	H1	H2	H3	Bag	Carton	W	PN
1631025	63 x 3/4" (20)	91	89	102	231	144	106	1	30	693	16
1631026	63 x 1" (25)	91	89	102	231	144	106	1	30	676	16
1631059	75 x 3/4" (20)	99	90	102	148	144	106	1	25	694	16
1631060	75 x 1" (25)	99	90	102	148	144	106	1	25	724	16
1631027	90 x 3/4" (20)	119	94	102	258	144	106	1	25	768	16
1631028	90 x 1" (25)	119	94	102	258	144	106	1	25	751	16
1631029	110 x 3/4" (20)	141	97	102	273	144	106	1	25	815	16
1631030	110 x 1" (25)	141	97	102	273	144	106	1	25	798	16
1631031	125 x 3/4" (20)	157	100	102	290	144	106	1	24	871	16
1631032	125 x 1" (25)	157	100	102	290	144	106	1	24	854	16
1631033	160 x 3/4" (20)	198	106	102	325	144	106	1	20	1019	16
1631034	160 x 1" (25)	198	106	102	325	144	106	1	20	1002	16
1631035	180 x 3/4" (20)	220	110	102	350	144	106	1	16	1123	16
1631036	180 x 1" (25)	220	110	102	350	144	106	1	16	1106	16
1631053	200 x 3/4" (20)	246	144	115	368	144	106	1	12	1233	16
1631054	200 x 1" (25)	246	144	115	368	144	111	1	12	1216	16

Plassaddle for Series 2 PVC Pipe AS1477 - Threaded Outlet 1630

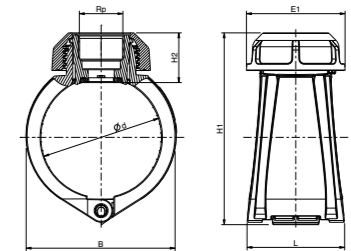

Product Code	Size d x d1	B	L1	E1	H1	H2	Bag	Carton	W	PN
1630016	DN100 (122) x 1/2"	157	100	102	198	52	1	36	566	16
1630017	DN100 (122) x 3/4"	157	100	102	198	52	1	36	567	16
1630018	DN100 (122) x 1"	157	100	102	198	52	1	36	570	16
1630019	DN100 (122) x 1.1/4"	157	100	102	207	61	1	36	567	16
1630020	DN100 (122) x 1.1/2"	157	100	102	198	52	1	36	560	16
1630030	DN150 (177) x 1/2"	220	110	102	255	52	1	24	822	16
1630031	DN150 (177) x 3/4"	220	110	102	255	52	1	24	805	16
1630032	DN150 (177) x 1"	220	110	102	264	61	1	24	817	16
1630033	DN150 (177) x 1.1/4"	220	110	102	255	52	1	24	820	16
1630034	DN150 (177) x 1.1/2"	220	110	102	255	52	1	24	802	16

Plassaddle Tapper for Series 2 PVC Pipe AS1477 - PE Compression Outlet

1631

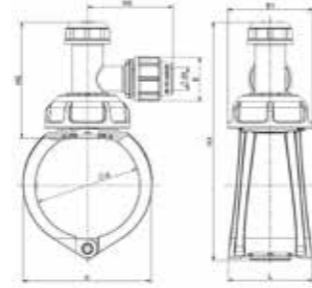

Product Code	Size d x d1	B	L	E1	H1	H2	H3	Bag	Carton	W	PN
1631007	DN100 (122) x 25	157	100	102	290	144	106	1	25	834	16
1631008	DN100 (122) x 32	157	100	102	290	144	111	1	16	845	16
1631013	DN150 (177) x 25	220	110	102	350	144	106	1	16	1073	16
1631014	DN100 (177) x 32	220	110	102	350	144	111	1	16	1103	16

Plassaddle Tapper for Series 2 PVC AS1477 - Copper Compression Outlet

1631

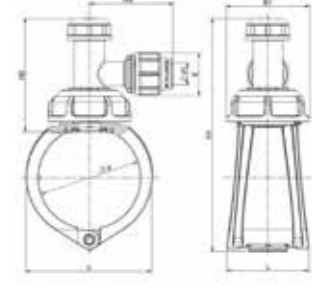

Product Code	Size d x d1	B	L	E1	H1	H2	H3	Bag	Carton	W	PN
1631045	DN100 (122) x 3/4"(20)	157	100	102	290	144	106	1	25	884	16
1631046	DN100 (122) x 1"(25)	157	100	102	290	144	111	1	25	984	16
1631047	DN150 (177) x 3/4"(20)	220	110	102	350	144	106	1	16	1103	16
1631048	DN100 (177) x 1"(25)	220	110	102	350	144	111	1	16	1203	16

Plassaddle Tapper for Series 2 PVC AS1477 - Male Threaded Outlet

1631

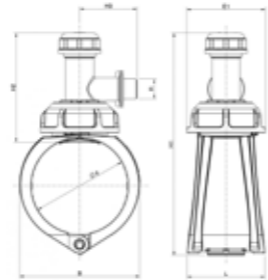

Product Code	Size d x d1	B	L	E1	H1	H2	H3	Bag	Carton	W	PN
1631020	DN100 (122) x 3/4"	157	100	102	290	144	131	1	25	832	16
1631040	DN100 (122) x 1"	157	100	102	290	144	78	1	25	797	16
1631024	DN150 (177) x 3/4"	220	110	102	350	144	131	1	20	1073	16
1631043	DN100 (177) x 1"	220	110	102	350	144	78	1	20	1039	16

Hex Key

2013



Product Code	Size d x d1
2013001	12 x 200mm

The Plasson Hex Key is designed for use with all Plasson tapping saddles. It comes with a 12mm square drive connection. Wrench not included.

 PLASSON

VALVES

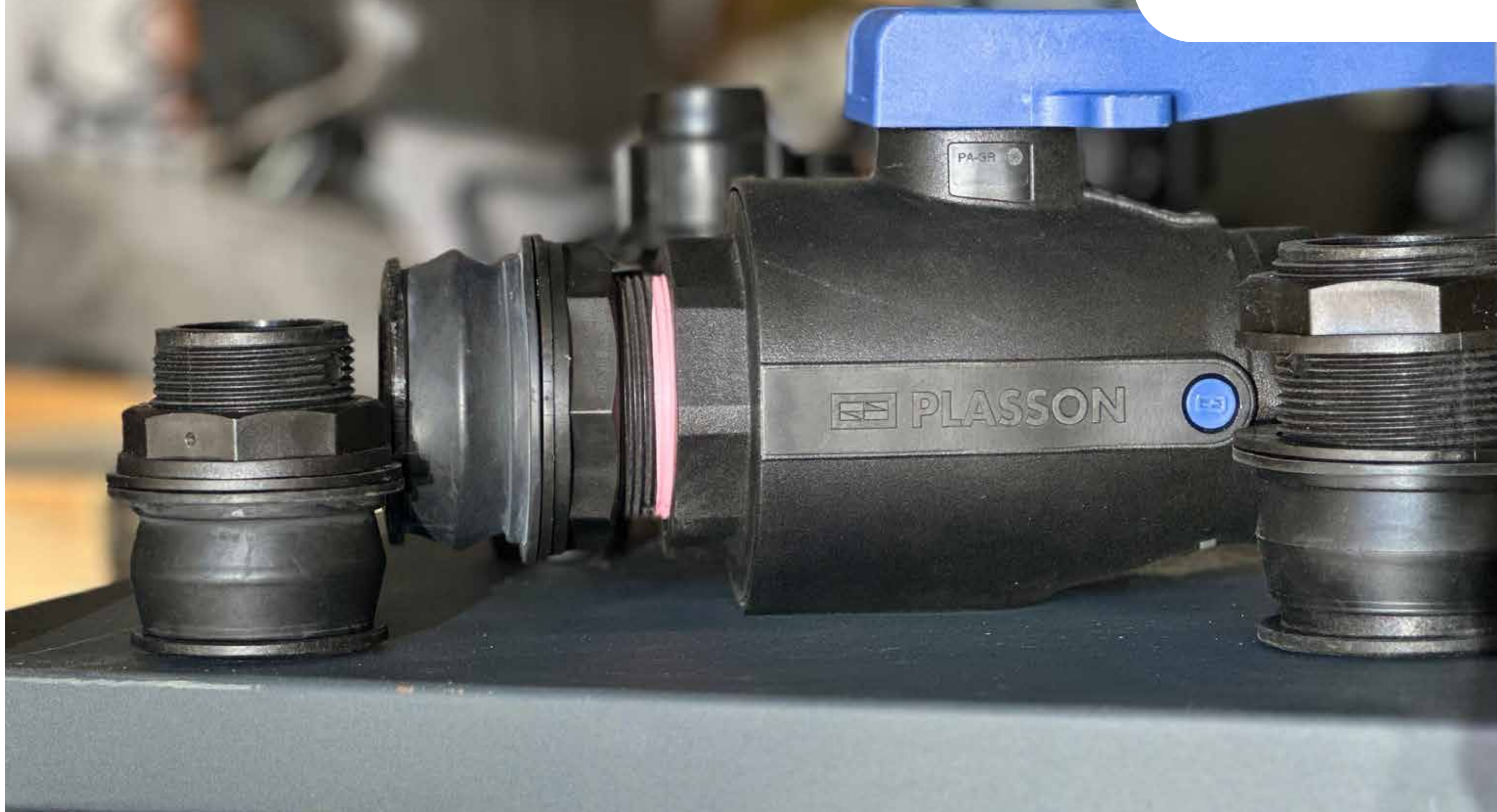

Valves

3703

Page 99 | Ball Valve



3703

Page 99 | Ball Valve Long Handle



3703

Page 99 | Ball Valve - Male / Female



3703

Page 100 | Ball Valve with Drain Port



3703

Page 100 | Ball Valve without Drain Port (Lilac Handle)



3703

Page 100 | Lilac Handle to Suit Ball Valve



1115 / 1114

Page 101 | Double Union: Female Threaded (Bistop)



1135

Page 101 | Single Union: Female Threaded



3405

Page 102 | Threaded Stoptap (Seal NBR)



3406

Page 102 | Compression Stoptap for Metric Pipes



3402

Page 102 | Compression Stoptap for Rural Pipes



3408

Page 103 | Poly to Copper Stoptap



3048

Page 103 | Angle Seat Valve - Threaded x Compression



3047

Page 103 | Angle Seat Valve - Threaded Inlet & Outlet



3046

Page 104 | Angle Seat Valve - Compression Inlet & Outlet



3049

Page 104 | Angle Seat Valve (Seal FPM) Threaded Inlet & Outlet



3067

Page 104 | Check Valve - Threaded Inlet & Outlet



4362

Page 106 | PE Ball Valve



4362

Page 106 | Telescopic Activating Rods



3039/3038

Page 107 | Quick Coupling Valve



3139

Page 107 | Riser / Key for Quick Coupling Valve





Ball Valve

3703

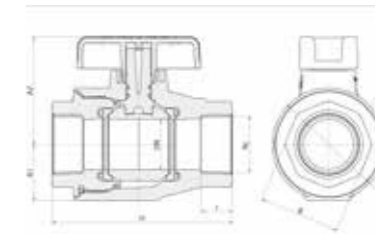

3703013* Locking Handle.

Product Code	Size DN x Rc	E	H	I	B	A1	A2	Bag	Carton	W	PN
3703018	15mm (1/2")	53	97	17.5	36	27	54	1	72	180	16
3703006	20mm (3/4")	53	97	17.5	36	27	54	1	72	175	16
3703007	25mm (1")	64	116	20.5	46	33	64	1	72	313	16
3703008	32mm (1.1/4")	73	118	20	55	36	70	1	48	393	16
3703022	40mm (1.1/2")	91	144	24	65	41	87	1	30	712	16
3703023	50mm (2")	106	162	29	75	53	95	1	24	918	16
3703013*	50mm (2")	106	162	29	75	53	95	1	24	920	16

* Comes with locking handle.

Ball Valve Long Handle

3703

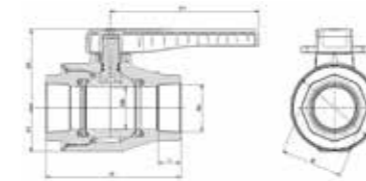

3703030* Lockable long handle + compression ends.

Product Code	Size DN x Rc	E	H	I	B	A1	A2	Carton	W	PN
3703009	40mm (1 1/2")	91	144	24	65	41	87	30	712	16
3703010	50mm (2")	106	162	29	75	53	95	24	918	16
3703030*	50mm (2")	100	430	29	75	140	-	10	1100	16

* Comes with lockable long handle + compression ends.

Ball Valve - Male / Female

3703

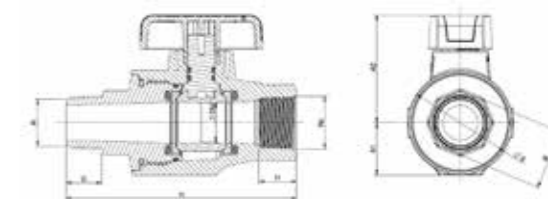

Product Code	Size R x Rc	DN	E	H	L1	B	L2	A1	A2	Bag	Carton	W	PN
3703040	1/2" x 1/2"	20	53	114	18	27	17	27	54	1	72	187	16
3703041	3/4" x 3/4"	20	53	117	19	30	18	27	54	1	72	182	16
3703042	1" x 1"	25	64	133	22	41	21	33	64	1	72	320	16

Ball Valve with Drain Port

3703



Black cap is removable for drain port applications.

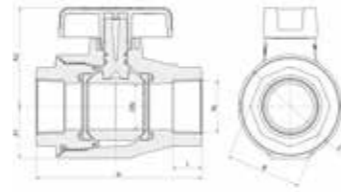

Product Code	Size DN x Rc	Drain Port	E	H	I	B	A1	A2	Bag	Carton	W	PN
3703021	15mm (1/2")	1/8"	53	97	17.5	36	27	54	1	72	180	16
3703001	20mm (3/4")	1/8"	53	97	17.5	36	27	54	1	72	175	16
3703002	25mm (1")	1/8"	64	116	20.5	46	33	64	1	72	313	16
3703003	32mm (1.1/4")	1/4"	73	118	20	55	36	70	1	48	393	16
3703004	40mm (1.1/2")	1/4"	91	144	24	65	41	87	1	30	712	16
3703005	50mm (2")	1/4"	106	162	29	75	53	95	1	24	918	16

Ball Valve without Drain Port (Lilac Handle)

3703

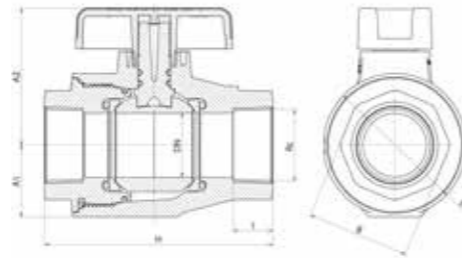

Product Code	Size DN x Rc	E	H	I	B	A1	A2	Bag	Carton	W	PN
3703033	25mm (1")	64	116	20.5	46	33	64	1	72	313	16
3703034	32mm (1.1/4")	73	118	20	55	36	70	1	48	393	16
3703035	40mm (1.1/2")	91	144	24	65	41	87	1	30	712	16
3703014	50mm (2")	106	162	29	75	53	95	1	24	918	16

Lilac Handle to Suit Ball Valve

3703



Product Code	Size to Suit
3703019	Suit 1" + 1.1/4" Ball Valve
3703016	Suit 1.1/2" + 2" Ball Valve

Double Union: Female Threaded (Bistop)

1114/1115

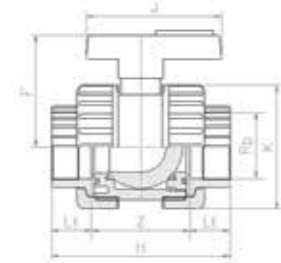

Product Code	Size DN x Rc	Lt	Z	J	H	F	K	Bag	Carton	W	PN
1115001	1/2" x 1/2"	15	45	75	45	65	45	1	160	105	16
1115002	3/4" x 3/4"	16	57	89	54	73	55	1	90	204	16
1115003	1" x 1"	19	64	102	66	78	66	1	50	284	16
1115004	1.1/4" x 1.1/4"	22	76	120	74	96	80	1	40	479	16
1115005	1.1/2" x 1.1/2"	22	98	142	86	110	96	1	28	681	16
1115006	2" x 2"	26	117	169	106	129	118	1	13	1439	16
1114001	2.1/2" x 2.1/2"	30	137	215	128	132	139	1	4	2000	10
1114002	3" x 3"	33	148	250	146	153	165	1	2	3250	10
1114003	4" x 4"	40	173	290	173	185	207	1	2	6300	10

Bitstop can be disassembled when live.

Single Union: Female Threaded

1135



Product Code	Size DN x Rc	Lt	Z	J	H	F	K	Bag	Carton	W	PN
1135001	1/2" x 1/2"	15	41	73	45	65	45	1	200	90	16
1135002	3/4" x 3/4"	16	49	87	54	73	55	1	110	159	16
1135003	1" x 1"	19	55	99	66	78	66	1	60	222	16
1135004	1.1/4" x 1.1/4"	22	64	116	74	96	80	1	45	376	16
1135005	1.1/2" x 1.1/2"	22	76	138	86	110	96	1	25	536	16
1135006	2" x 2"	26	90	166	106	129	118	1	15	1109	16

Threaded Stoptap (Seal NBR)

3405

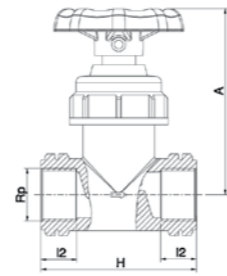

Product Code	Size Rp x Rp	H	I2	A	Bag	Carton	W	PN
3405001	3/4" x 3/4"	78	18	95	5	140	115	16
3405002	1" x 1"	82	20	95	5	120	129	16

Poly to Copper Stoptap

3408

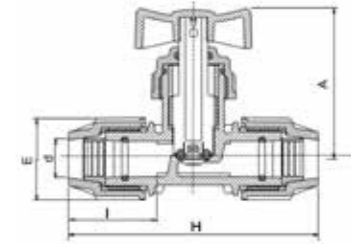

Product Code	Size d x d	E	H	I	A	Bag	Carton	W	PN
3408001	20 x 15 (1/2")	48	147	58	101	5	100	160	16
3408002	25 x 20 (3/4")	54	157	60	91	5	70	160	16

Compression Stoptap for Metric Pipes

3406

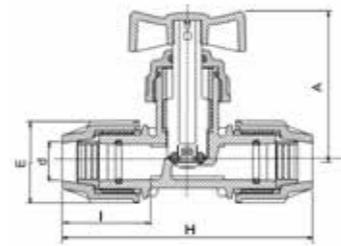

Product Code	Size d x d	E	H	I	A	Bag	Carton	W	PN
3406001	20 x 20	48	147	58	101	5	100	171	16
3406002	25 x 25	54	157	60	91	5	80	190	16
3406003	32 x 32	64	163	70	95	5	60	264	16

Angle Seat Valve - Threaded x Compression

3048

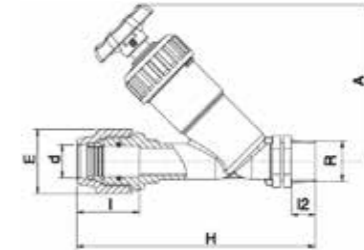

Product Code	Size d x R	E	H	I	I2	A	Bag	Carton	W	PN
3048001	20 x 1/2"	48	174	57	16	113	1	100	176	16
3048002	25 x 3/4"	54	187	60	18	121	1	80	238	16
3048003	32 x 1"	64	212	70	20	140	1	50	360	16
3048004	40 x 1 1/4"	82	299	84	22	180	1	26	600	16
3048005	50 x 1 1/2"	96	259	93	22	207	1	17	925	16
3048006	63 x 2"	113	340	110	26	246	1	10	1518	16

Compression Stoptap for Rural Pipes

3402

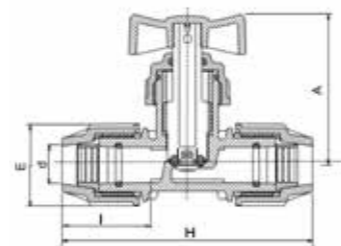

Product Code	Size d x d	E	H	I	A	Bag	Carton	W
3402001	20 x 20	48	147	58	101	5	90	181
3402002	25 x 25	54	157	60	91	5	70	216
3402003	32 x 32	64	163	70	95	5	60	299

Angle Seat Valve - Threaded Inlet & Outlet

3047

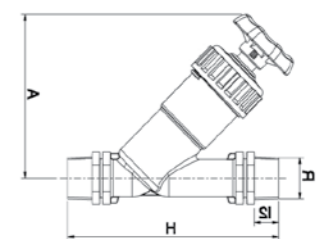

Product Code	Size R x R	H	I2	A	Bag	Carton	W	PN
3047001	1/2" x 1/2"	135	16	113	5	120	142	8
3047002	3/4" x 3/4"	151	18	121	5	100	186	8
3047003	1" x 1"	170	20	140	1	70	291	8
3047004	1 1/4" x 1 1/4"	225	22	207	1	40	474	8
3047005	1 1/2" x 1 1/2"	200	22	180	1	24	733	8
3047006	2" x 2"	254	26	246	1	15	1191	8

Angle Seat Valve - Compression Inlet & Outlet

3046

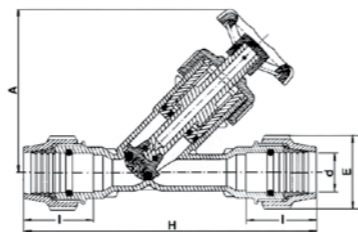

Product Code	Size d x d	E	H	I	A	Bag	Carton	W	PN
3046001	32 x 32	64	254	70	140	1	40	438	8

Angle Seat Valve (Seal FPM) Threaded Inlet & Outlet

3049

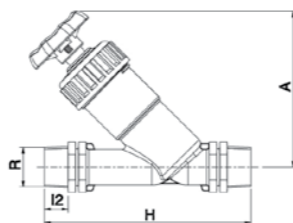

Product Code	Size R x R	H	I2	A	Bag	Carton	W	PN
3049001	1/2" x 1/2"	135	16	113	5	120	136	8
3049002	3/4" x 3/4"	151	18	121	5	100	191	8
3049003	1" x 1"	170	20	140	1	70	295	8
3049004	1 1/4" x 1 1/4"	200	22	180	1	40	474	8
3049005	1 1/2" x 1 1/2"	225	22	207	1	24	733	8
3049006	2" x 2"	254	26	246	1	15	1207	8

Check Valve - Threaded Inlet & Outlet

3067

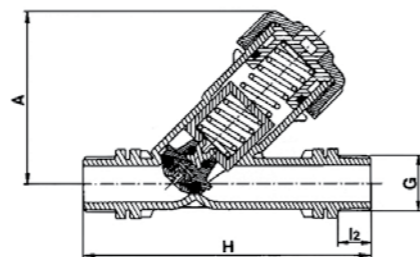

Product Code	Size R x R	H	I2	A	Bag	Carton	W	PN
3067001	3/4" x 3/4"	151	18	96	5	140	141	8
3067002	1" x 1"	170	20	106	5	100	210	8
3067003	1 1/4" x 1 1/4"	200	22	134	1	55	382	8
3067004	1 1/2" x 1 1/2"	225	22	155	1	35	586	8
3067005	2" x 2"	254	26	182	1	20	975	8

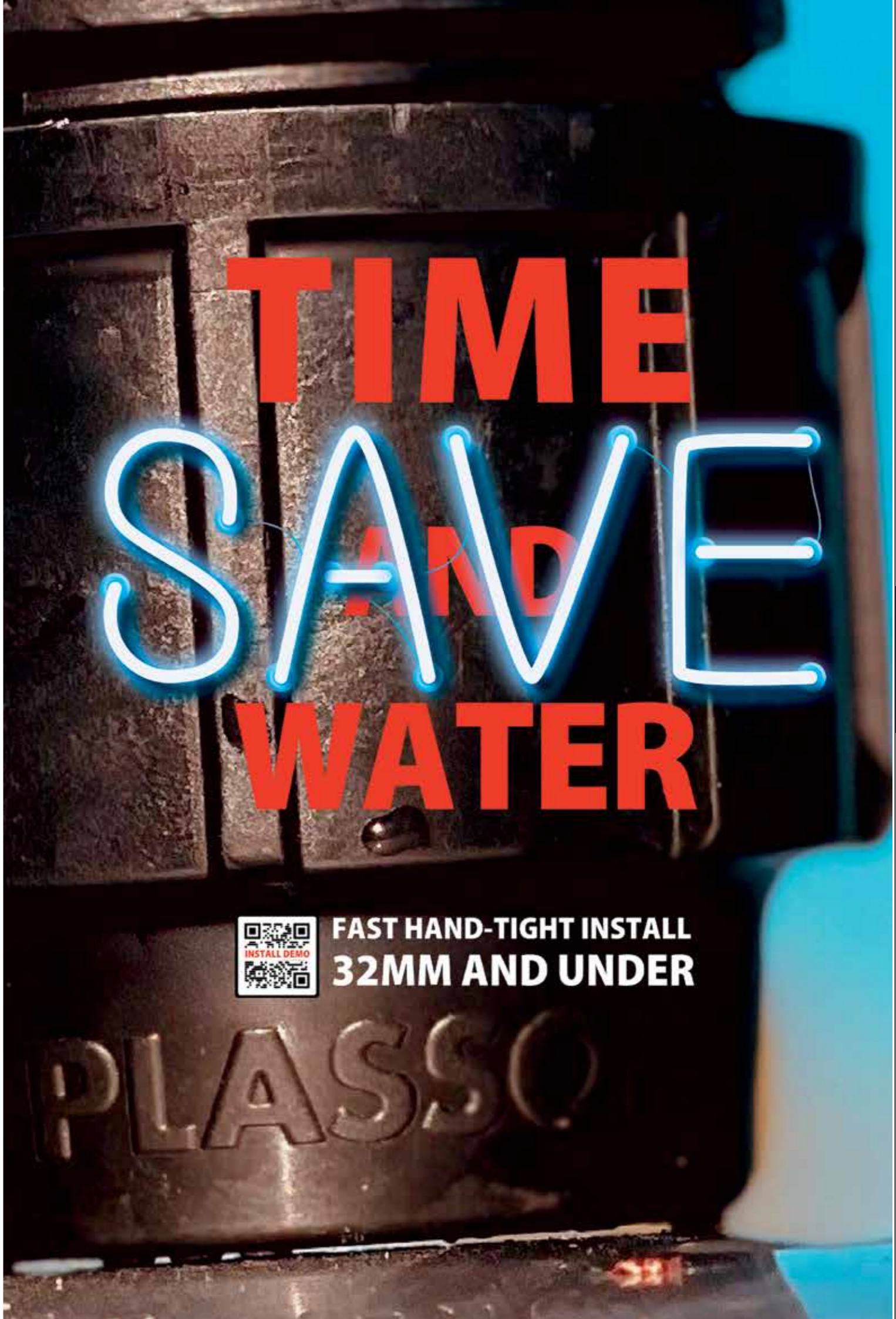

**FAST HAND-TIGHT INSTALL
32MM AND UNDER**

PLASSO

PE Ball Valve

4362

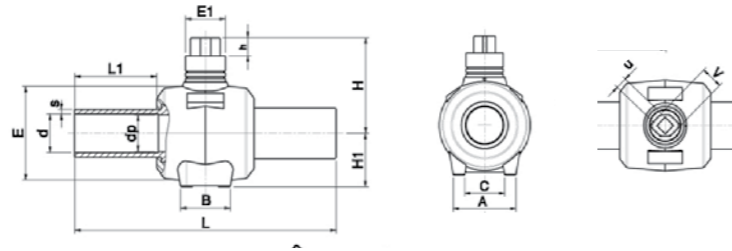

Product Code	d	A	B	C	Dp	E	E1	H	H1	L	L1	S	U	V	PN	Gas
4362001	25	60	65	39	19*	80	70	94	50	300	103	3	26	50	PN16	SDR11
4362002	32	60	65	39	24*	80	70	94	50	300	103	3.4	26	50	PN16	SDR11
4362003	40	60	65	39	24*	80	70	94	50	300	103	4.1	26	50	PN16	SDR11
4362004	50	85	87	54	39*	120	85	160	80	414	130	5.5	26	50	PN16	SDR11
4362005	63	85	87	54	48*	120	85	160	80	414	130	6	26	50	PN16	SDR11
4362006	75	85	87	54	48	120	85	160	80	414	130	8	26	50	PN16	SDR11
4362007	90	146	93	90	70*	200	85	200	110	550	176	8.2	26	50	PN16	SDR11
4362008	110	146	93	90	86*	200	85	200	110	550	178	10	26	50	PN16	SDR11
4362009	125	146	93	90	86*	200	85	200	110	550	182	11.7	26	50	PN16	SDR11
4362010	160	146	93	90	86	200	85	200	110	550	182	16	26	50	PN16	SDR11

Telescopic Activating Rods

3038



Product Code	Suits PE Ball Valve Sizes	Telescopic length range (mm)	TopRod Size \varnothing	W
3008007	25-40	600-900	14	1700
3008008	50-160	600-900	30	1700

Quick Coupling Valve

3039/3038

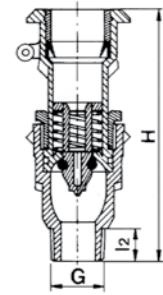

Product Code	Size R	H	I2	Bag	Carton	W	PN
3039001	3/4" Yellow	152	17	5	130	146	10
3038001	3/4" Lilac	152	17	5	130	146	10
3039002	1" Yellow	154	18	5	130	148	10
3038002	1" Lilac	154	18	5	130	148	10

Spare Parts

3039003	Plunger for 3/4", 1" QCV
3039004	Plunger Spring for 3/4", 1" QCV
3039005	Insert for 3/4", 1"
3039006	Rubber Cuff for 3/4", 1" QCV
3039007	Cap Pin for 3/4", 1"
3039008	Yellow Cap for 3/4", 1"
3038003	Lilac Cap for 3/4", 1"
3039009	Valve Body (Upper) for 3/4", 1"
3039010	Nut for 3/4", 1"
3039011	Upper Body Seal for 3/4", 1"
3039012	Valve Washer for 3/4", 1"
3039013	Valve Body (Lower) 1"
3039014	Valve Body (Lower) 3/4"

Riser / Key for Quick Coupling Valve

3139

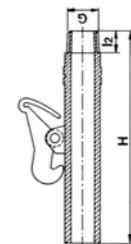

Product Code	Size R	H	I2	Bag	Carton	W
3139001	3/4"	173	18	5	250	66

Spare Parts

3139002	Riser Clip
3139003	Riser Pin



PLASSON

ELECTROFUSION FITTINGS

4901
Page 114-115 | Coupler 

4901
Page 115 | Long Coupler 

4501
Page 116 | Coupler (Thick Wall) 

4601
Page 116-117 | LightFit Coupler (PN10) 

4601
Page 117 | Super LightFit Coupler 

4911
Page 118 | Reducing Coupler 

4911
Page 118 | Reducing Coupler - Metric to Imperial 

4900
Page 119 | Flex Restraint 

4912
Page 119 | Monolithic End Cap 

4912
Page 120 | End Cap 

4912
Page 120 | Test End Cap 

4912
Page 121 | End Plug 

4902
Page 121 | Hydrant Flange 

4904
Page 122 | 90° Equal Tee 

4924
Page 122 | Two Outlets Reducing Tee 

4914
Page 123 | Reducing Tee 

4994
Page 124 | Flanged Tee 

4905
Page 124 | 90° Elbow 

4906
Page 125 | 45° Elbow 

4908
Page 125 | 22.5° Elbow 

4637
Page 126 | 15° LightFit Elbow 

4633
Page 126 | 30° LightFit Elbow 

470/4606
Page 126 | 45° LightFit Elbow 

4909
Page 127 | 180° Elbow 

4919
Page 127 | Y Reducer 

4915
Page 127 | Duckfoot 90° Elbow 

4915
Page 128 | Duckfoot 90° Elbow With Outlet 

4947
Page 128 | Adjustable Elbow 

4947
Page 129 | Adjustable Elbow One Sided 

4958
Page 129 | Saddle Female Threaded Outlet 

4952
Page 130 | Repair Saddle with Underpart 

4952
Page 130 | Double Repair Saddle 

4952
Page 130 | Repair Saddle 

4938
Page 131 | Transition Saddle 

4938
Page 131 | Large Bore Transition Saddle 

4938
Page 132 | Sensor Saddle with a S/S Thread 

4958
Page 133 | Branch Saddle 

4958
Page 134 | Branch Saddle with Red Wire Underpart & Test Spigot 

4958
Page 134 | Large Bore Branch Saddle 

4958
Page 135-136 | XL & XXL Branch Saddle 

4758
Page 136 | LightFit Branch Saddle 

4913
Page 137 | High Volume Tapping Tee (HVTT) 

2013
Page 137 | Hex Key 

4963
Page 138-139 | Tapping Saddle 

4983
Page 139 | Welding Cap for Tapping Saddle 

4954
Page 140 | Tapping Valve 

4921
Page 141 | Male Transition Coupler 

4931
Page 141 | Female Transition Coupler 

4951
Page 142 | Male Transition Coupler S/S 316 

4941
Page 142 | Male Transition Union (Free Nut) 

4971
Page 143 | PE Male Spigot Adaptor 

4961
Page 143 | PE Female Spigot Adaptor 

4925
Page 144 | Male Transition 90° Elbow 

4935
Page 144 | Female Transition 90° Elbow 

4926
Page 145 | Male Transition 45° Elbow 

4936
Page 145 | Female Transition 45° Elbow 

4941
Page 146 | Female Free Nut Transition Coupler 

4945
Page 146 | Female Free Nut Transition 90° Elbow 

4946
Page 147 | Female Free Nut Transition 45° Elbow 

4971
Page 147 | PE Male Transition Coupler 

4977
Page 148 | PE Cast Iron Flange Transition Coupler 

4977
Page 148 | PE-Steel Weldable Transitions 

4977
Page 149 | PE-Steel Weldable Transitions 

4758
Page 149 | Wastewater Adjustable Saddle 

4758
Page 149 | Wastewater 45° Saddle - Inlet 110 

4758
Page 150 | Wastewater Saddle Spigot Inlet 

3702/4772
Page 150 | Wastewater Manhole Adaptor 

Plasson Control Box Suitability



DN	SmartFuse 180	SmartFuse 355	Polymatic Plus USB	Poly Control Plus V2
16-180	✓	✓	✓	✓
200-355	x	✓	✓	✓
400-800	x	x	✓*	✓
800-1200	x	x	x	✓

*Sizes above 355mm require cool down time between welds.

Standard dimension ratios (SDRs) for series 1 PE pipes and equivalent pressure rating in Bar

Compound	PN3.2	PN4	PN6.3	PN8	PN10	PN12.5	PN16	PN20	PN25
PE80	41	33	21	17	13.6	11	9	7.4	-
PE100	-	41	26	21	17	13.6	11	9	7.4

Coupler

4901

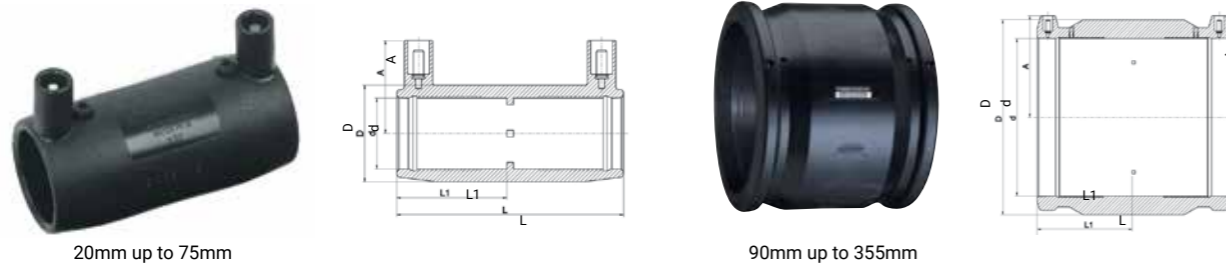

Product Code	Size d	L	L1	D	A	Carton	W	PN Water	SDR Gas	SDR Pipe Suitability
4901001	16	71	34	35	39	480	58	16	11	7.4-11
4901002	20	76	37	31	34	440	50	16	11	7.4-11
4901003	25	82	40	36	37	360	40	16	11	7.4-11
4901004	32	88	42	44	42	256	64	16	11	7.4-11
4901005	40	97	47	56	46	200	97	16	11	7.4-17
4901006	50	101	49	67	51	132	161	16	11	7.4-17
4901007	63	118	58	82	56	72	230	16	11	7.4-17
4901008	75	127	62	98	62	60	340	16	11	7.4-17
4901009	90	148	73	112	71	38	475	16	11	7.4-17
4901010	110	163	80	135	81	23	718	16	11	7.4-17
4901011	125	173	85	157	87	18	1075	16	11	7.4-17
4901012	140	183	90	174	97	12	1295	16	11	7.4-17
4901013	160	195	93	194	105	6	1555	16	11	7.4-21
4901014	180	212	105	218	116	5	2112	16	11	7.4-17
4901015	200	223	109	242	126	4	2785	16	11	7.4-17
4901016	225	240	119	272	138	4	3900	16	11	7.4-17
4901017	250	251	123	301	156	2	4461	16	11	7.4-21
4901018	280	275	134	342	170	1	6440	16	11	7.4-17
4901019	315	282	139	387	184	1	8845	16	11	7.4-26
4901020	355	277	137	431	203	1	10200	16	11	7.4-17
4901021	400	293	145	485	231	1	13800	16	11	7.4-26

Coupler Cont.

4901



Product Code	Size d	L	L1	D	A	Carton	W	PN Water	SDR Gas	Pipe SDR Suitability
4901022	450	306	153	539	257	1	16000	16	11	7.4-21
4901023	500	340	170	603	283	1	20200	16	11	7.4-21
4901024	560	376	188	674	317	1	28000	16	11	11-33
4901025	630	418	209	759	356	1	41100	16	11	7.4-33
4901026	710	472	236	853	400	1	62000	16	11	7.4-26
4901027	800	500	250	955	450	1	87000	16	11	7.4-21
4901034	900	500	250	1070	503	1	100100	16	11	11-21
4901035	1000	570	285	1194	563	1	100000	16	11	11-21

Series 3 couplers up to DN300 available on request. 450mm - 1000mm have dual weld zones.

Long Coupler

4901



Product Code	Size d	L	L1	D	A	Carton	W	PN Water	SDR Gas	Pipe SDR Suitability
4901028	32	104	50	44	43	272	80	16	11	7.4-11
4901029	40	121	59	56	46	128	140	16	11	7.4-11
4901030	50	139	68	68	51	96	220	16	11	7.4-11
4901031	63	166	81	82	57	48	320	16	11	7.4-11

Coupler (Thick Wall)

4501

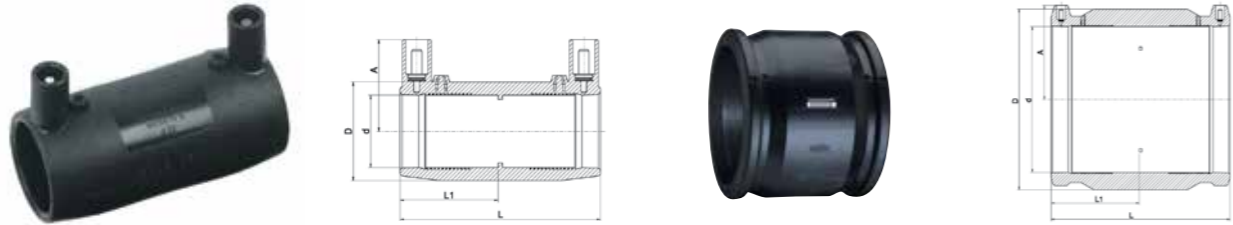

Product Code	Size d	L	L1	D	A	Carton	W	PN Water	SDR Gas	Pipe SDR Suitability
4501001	50	100	49	68	52	132	151	25	7.4	7.4-11
4501002	63	118	57	82	58	72	233	25	7.4	7.4-11
4501003	75	126	62	97	65	60	339	25	7.4	7.4-11
4501004	90	148	73	117	69	38	571	25	7.4	7.4-11
4501005	110	163	80	140	79	23	860	25	7.4	7.4-11
4501006	125	173	85	157	87	18	1087	25	7.4	7.4-11
4501016	140	181	89	175	103	12	1320	25	7.4	7.4-11
4501007	160	198	97	198	105	6	1780	25	7.4	7.4-11
4501008	180	212	104	224	114	4	2449	25	7.4	7.4-11
4501009	200	223	110	249	126	4	3295	25	7.4	7.4-11
4501010	225	240	118	280	140	4	4460	25	7.4	7.4-11
4501011	250	256	127	310	155	2	5610	25	7.4	7.4-11
4501012	280	274	135	341	166	1	6470	25	7.4	7.4-11
4501013	315	284	140	381	184	1	8884	25	7.4	7.4-11
4501015	355	280	138	430	204	1	10438	25	7.4	7.4-11
4501014	400	324	162	502	231	1	22000	20	9	7.4-11

LightFit Coupler (PN10)

4601



Product Code	Size d	L	L1	D	A	Carton	W	PN Water	SDR Gas	Pipe SDR Suitability
4601001	40	90	43	56	47	200	100	10	17	7.4-17
4601002	50	100	49	68	52	132	149	10	17	7.4-17
4601003	63	118	57	77	57	112	160	10	17	11-26
4601004	75	126	61	90	63	60	216	10	17	11-26
4601005	90	148	72	108	69	44	360	10	17	11-26
4601006	110	163	80	131	81	25	570	10	17	11-33
4601007	125	173	85	149	87	20	760	10	17	11-33
4601008	140	182	89	167	94	12	970	10	17	11-33
4601009	160	198	97	193	104	6	1390	10	17	11-33
4601010	180	212	104	215	114	5	1735	10	17	11-33
4601011	200	232	114	235	127	4	2110	10	17	11-33
4601012	225	240	118	264	141	4	2825	10	17	11-33
4601013	250	256	126	293	155	2	3728	10	17	11-33
4601014	280	275	135	332	166	1	5380	10	17	11-33
4601015	315	284	140	374	184	1	7100	10	17	11-33
4601016	355	280	138	421	204	1	8823	10	17	11-41
4601017	400	296	146	474	227	1	12000	10	17	11-41

LightFit Coupler Cont. (PN10)

4601



450mm up to 1200mm

Product Code	Size d	L	L1	D	A	Carton	W	PN Water	SDR Gas	Pipe SDR Suitability
4601018	450	310	155	518	255	1	11700	10	17	11-41
4601019	500	340	170	576	283	1	16000	10	17	11-33
4601020	560	376	188	625	309	1	21510	10	17	11-41
4601021	630	400	200	706	347	1	27000	10	17	11-33
4601022	710	440	220	797	390	1	43100	10	17	11-33
4601023	800	470	235	897	440	1	57300	10	17	11-41
4601024	900	500	250	1010	500	1	68400	10	17	11-41
4601026	1000	540	270	1128	555	1	99260	10	17	11-33
4601025	1200	600	300	1355	667	1	150000	10	17	17-33

450mm - 1200mm have dual weld zones.

Super LightFit Coupler

4601



Product Code	Size d	L	L1	D	A	Carton	W	PN Water*	SDR Gas	Pipe SDR Suitability
4601101	500	300	150	550	272	1	11800	6.4	26	26-41
4601102	560	310	155	620	310	1	15300	6.4	26	17-41
4601103	630	320	160	693	346	1	18200	6.4	26	26-33
4601105	710	380	190	775	388	1	25800	6.4	26	17-41
4601104	800	400	200	876	438	1	34700	6.4	26	26-41
4601107	900	420	210	983	485	1	40500	6.4	26	17-41
4601106	1000	440	220	1085	534	1	48000	6.4	26	17-41

*Nominated rating. Not certified to AS/NZS 4129.

Reducing Coupler

4911

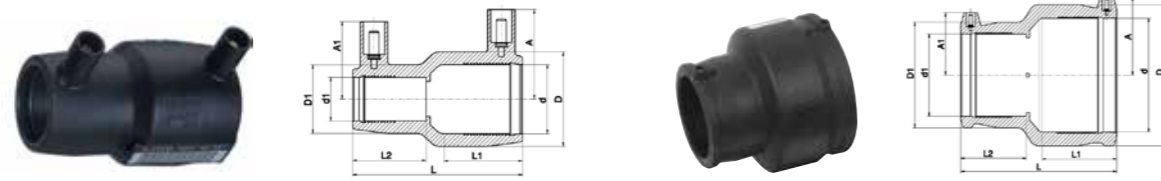

20 x 16mm up to 110 x 90mm

125 x 90mm up to 180 x 125mm

Product Code	Size d x d1	L	A	A1	L1	L2	D	D1	Carton	W	PN Water	SDR Gas	Pipe SDR Suitability
4911001	20 x 16	71	39	39	35	35	36	36	480	54	16	11	7.4-11
4911058	25 x 16	71	39	39	35	35	36	36	480	49	16	11	7.4-11
4911002	25 x 20	71	39	39	35	35	36	36	480	46	16	11	7.4-11
4911059	32 x 16	81	42	34	39	35	44	32	360	58	16	11	7.4-11
4911004	32 x 20	81	43	37	40	35	45	32	360	59	16	11	7.4-11
4911005	32 x 25	81	43	39	40	35	45	36	360	56	16	11	7.4-11
4911060	40 x 20	90	44	38	44	40	56	36	360	58	16	11	7.4-11
4911006	40 x 25	90	47	38	44	40	56	37	200	86	16	11	7.4-11
4911007	40 x 32	90	47	43	44	40	56	44	160	92	16	11	7.4-11
4911008	50 x 25	100	52	41	49	41	68	37	160	118	16	11	7.4-11
4911009	50 x 32	100	52	45	49	40	68	45	128	123	16	11	11-17
4911010	50 x 40	100	52	48	49	44	68	56	128	135	16	11	7.4-17
4911012	63 x 32	119	59	45	57	40	82	45	96	180	16	11	7.4-17
4911013	63 x 40	119	59	49	57	44	82	56	96	192	16	11	7.4-17
4911014	63 x 50	119	59	54	57	49	82	68	80	224	16	11	7.4-17
4911016	75 x 63	126	66	59	66	57	98	82	65	314	16	11	7.4-17
4911017	90 x 50	143	78	53	71	49	116	69	54	430	16	11	7.4-13.6
4911018	90 x 63	143	78	61	71	57	116	82	44	460	16	11	7.4-13.6
4911019	90 x 75	143	78	67	71	61	116	98	41	480	16	11	7.4-17
4911020	110 x 63	161	84	61	78	57	139	82	32	639	16	11	7.4-17
4911021	110 x 90	161	84	74	78	72	139	116	23	740	16	11	7.4-17
4911022	125 x 90	171	88	70	85	72	158	116	18	1019	16	11	7.4-17
4911023	125 x 110	171	88	80	85	78	158	141	18	1025	16	11	7.4-17
4911024	160 x 90	193	105	69	94	72	199	116	12	1440	16	11	7.4-17
4911025	160 x 110	193	105	80	94	81	199	141	12	1520	16	11	7.4-17
4911026	160 x 125	195	105	89	94	85	199	158	6	1570	16	11	7.4-17
4911027	180 x 125	212	116	87	103	85	222	158	6	2060	16	11	7.4-17

Reducing Coupler - Metric to Imperial

4911



Product Code	Size d x d1 (IPS)	L	A	A1	L1	L2	D	D1	Carton	W	PN Water	SDR Gas	Pipe SDR Suitability
4911003	25 x 3/4"	71	39	39	35	35	36	36	480	46	16	11	11-11
4911011	50 x 1/2"	100	52	48	49	44	68	56	128	135	16	11	7.4-11
4911015	63 x 2"	119	59	54	57	49	82	68	80	224	16	11	11-11

Flex Restraint

4900



Product Code	Size	L	H	B	Carton	W
4900001	160-1600	202	40	65	60	300

Dedicated tools in tooling section.
Each unit restrains 31,000N (3,100kg) of axial force. Use multiple units to restrain higher forces.
Welding with barcode unit only.
Requires temperature compensation.

Monolithic End Cap

4912



Product Code	Size d	L	L1	D	A	Carton	W	PN Water	SDR Gas	Pipe SDR Suitability
4912003	32	63	44	44	46	432	50	16	11	7.4-11
4912004	40	70	48	55	51	256	75	16	11	7.4-11
4912005	50	82	55	68	56	192	122	16	11	7.4-11
4912006	63	95	62	81	62	96	182	16	11	7.4-11

End Cap

4912



20mm up to 75mm



90mm up to 315mm

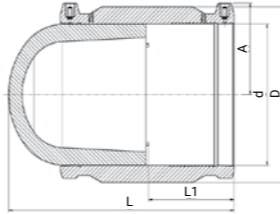

Product Code	Size d	L	L1	D	A	Carton	W	PN Water	SDR Gas	Pipe SDR Suitability
4912001	20	84	37	31	34	400	55	16	11	7.4-11
4912002	25	92	40	36	37	400	50	16	11	7.4-11
4912035	32	103	42	44	42	300	76	16	11	7.4-11
4912036	40	114	47	56	46	160	130	16	11	7.4-17
4912037	50	121	49	67	51	120	204	16	11	7.4-17
4912038	63	142	57	82	57	72	327	16	11	7.4-17
4912007	75	156	61	98	64	48	499	16	11	7.4-17
4912008	90	183	73	117	70	30	820	16	11	7.4-17
4912009	110	206	78	140	81	20	1259	16	11	7.4-17
4912010	125	222	85	157	87	15	1702	16	11	7.4-17
4912011	140	237	90	174	97	10	2346	16	11	7.4-17
4912012	160	261	93	194	105	6	2990	16	11	7.4-21
4912013	180	283	105	218	116	5	4159	16	11	7.4-17
4912014	200	289	109	242	126	4	5260	16	11	7.4-17
4912015	225	318	119	272	138	2	7260	16	11	7.4-17
4912016	250	344	123	311	156	2	8380	16	11	7.4-21
4912039	280	396	134	340	170	1	11740	16	11	7.4-17
4912040	315	405	139	387	184	2	16050	16	11	7.4-26

End Plug

4912

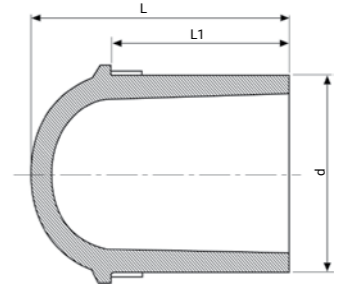

Product Code	Size d	L	L1	Carton	W	PN Water	SDR Gas
4912017	20	43	35	2000	8	16	11
4912018	25	46	36	1600	10	16	11
4912019	32	52	39	960	17	16	11
4912020	40	59	43	560	29	16	11
4912021	50	68	48	352	52	16	11
4912022	63	81	57	192	95	16	11
4912023	75	90	60	132	149	16	11
4912024	90	105	70	72	250	16	11
4912025	110	121	78	57	430	16	11
4912026	125	131	82	36	596	16	11
4912027	140	142	87	25	797	16	11
4912028	160	157	94	18	1149	16	11
4912029	180	172	101	14	1600	16	11
4912030	200	178	112	10	2089	16	11
4912031	225	196	120	6	2800	16	11
4912032	250	216	130	4	3920	16	11
4912033	280	257	162	3	5300	16	11
4912034	315	262	167	2	7200	16	11

Test End Cap

4912

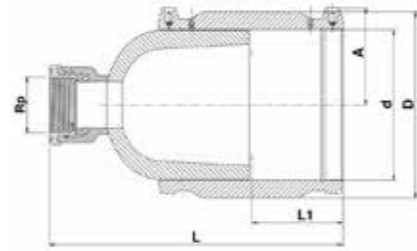

Product Code	Size d x Rp	L	L1	D	A	Carton	W	PN Water	SDR Gas	Pipe SDR Suitability
4931100	90 X 2"	250	73	117	70	20	1450	16	11	7.4-17
4931101	110 X 2"	273	78	140	81	14	1889	16	11	7.4-17
4931102	125 X 2"	289	85	157	87	12	2332	16	11	7.4-17
4931103	140 X 2"	304	90	174	97	8	2976	16	11	7.4-17
4931104	160 X 2"	328	93	194	105	8	3620	16	11	7.4-21
4931105	180 X 2"	358	105	218	116	4	4789	16	11	7.4-17
4931106	200 X 2"	356	109	242	126	4	5890	16	11	7.4-17
4931107	225 X 2"	385	119	272	138	2	7890	16	11	7.4-17
4931108	250 X 2"	411	123	311	156	1	9010	16	11	7.4-21
4931109	280 X 2"	463	134	340	170	1	12370	16	11	7.4-17
4931110	315 X 2"	472	139	387	184	1	16680	16	11	7.4-26

Hydrant Flange comes with AS4087 PN16 SS316 backing ring

4902

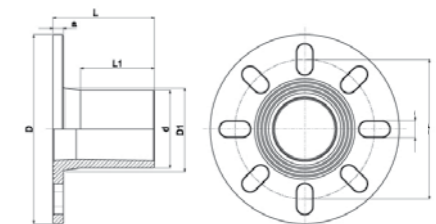

Product Code	Size d	Flange	D	L	L1	a	W	PN Water	SDR Gas
4902004*	90	Dual 3" and 4"	220	118	86	12	330	16	11
4902007	90	3"	220	118	86	12	220	16	11

*Suits 80 to 100mm fire hydrant mountings - max ID of mating flange 80mm.

90° Equal Tee

4904

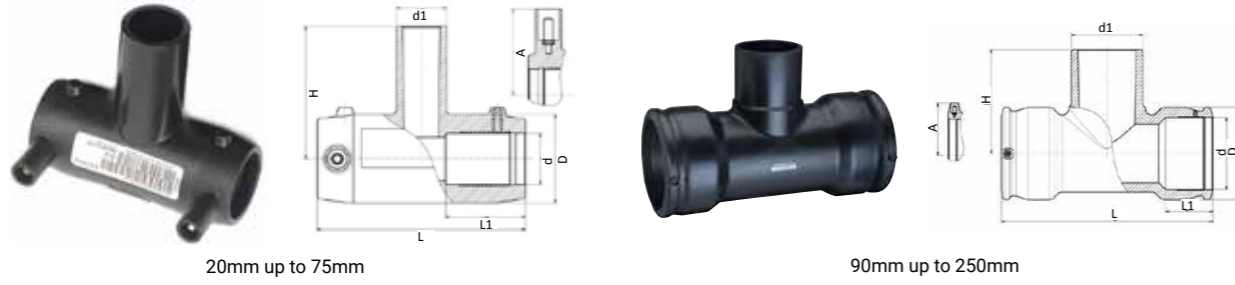

Product Code	Size d x d1 x d	L	L1	D	H	A	Carton	W	PN Water	SDR Gas	Pipe SDR Suitability
4904001	20 x 20 x 20	96	37	33	60	39	260	61	16	11	7.4-11
4904002	25 x 25 x 25	103	39	44	66	43	168	110	16	11	7.4-11
4904003	32 x 32 x 32	104	39	44	74	43	144	97	16	11	7.4-11
4904004	40 x 40 x 40	120	43	56	90	47	96	165	16	11	7.4-17
4904005	50 x 50 x 50	139	48	68	102	52	56	257	16	11	7.4-17
4904006	63 x 63 x 63	167	58	82	119	58	32	417	16	11	7.4-17
4904007	75 x 75 x 75	196	63	96	129	62	26	639	16	11	7.4-17
4904008	90 x 90 x 90	294	71	113	137	71	15	1090	16	11	7.4-17
4904009	110 x 110 x 110	326	71	143	160	81	8	1955	16	11	7.4-17
4904010	125 x 125 x 125	382	86	165	177	88	4	2950	16	11	7.4-17
4904011	160 x 160 x 160	396	97	209	222	105	3	4758	16	11	7.4-17
4904012	180 x 180 x 180	422	106	245	250	116	1	7200	16	11	7.4-17
4904013	200 x 200 x 200	451	114	261	265	125	1	8650	16	11	7.4-17
4904014	225 x 225 x 225	494	122	293	290	140	1	11860	16	11	7.4-17
4904015	250 x 250 x 250	538	129	326	315	152	1	16250	16	11	7.4-17

Reducing Tee

4914



Product Code	Size dxd1xd	L	L1	D	H	A	Carton	W	PN Water	SDR Gas	Pipe SDR Suitability
4914001	25 x 20 x 25	104	39	44	66	43	168	108	16	11	7.4-11
4914002*	25 x 32 x 25*	104	39	44	74	43	168	116	16	11	7.4-11
4914003	32 x 20 x 32	104	39	44	66	43	144	89	16	11	7.4-11
4914004	32 x 25 x 32	104	39	44	66	43	144	91	16	11	7.4-11
4914005	40 x 20 x 40	120	43	56	72	47	96	151	16	11	7.4-17
4914006	40 x 25 x 40	120	43	56	72	47	96	150	16	11	7.4-17
4914007	40 x 32 x 40	120	43	56	75	47	96	152	16	11	7.4-17
4914008	50 x 20 x 50	139	48	68	78	52	64	224	16	11	7.4-17
4914009	50 x 25 x 50	139	48	68	78	52	64	225	16	11	7.4-17
4914010	50 x 32 x 50	139	48	68	86	52	64	228	16	11	7.4-17
4914011	50 x 40 x 50	139	48	68	90	52	64	237	16	11	7.4-17
4914012	63 x 20 x 63	167	49	82	85	58	40	348	16	11	7.4-17
4914013	63 x 32 x 63	167	58	82	93	58	32	353	16	11	7.4-17
4914014	63 x 40 x 63	167	58	82	104	58	32	365	16	11	7.4-17
4914015	63 x 50 x 63	167	58	82	109	58	32	381	16	11	7.4-17
4914016	75 x 63 x 75	196	63	96	122	62	26	607	16	11	7.4-17
4914017	90 x 63 x 90	294	68	113	124	71	15	1050	16	11	7.4-17
4914037	90 x 75 x 90	293	71	112	137	71	15	1045	16	11	7.4-17
4914018	110 x 63 x 110	326	71	143	134	81	9	1715	16	11	7.4-17
4914036	110 x 75 x 110	328	72	143	142	81	9	2162	16	11	7.4-17
4914019	110 x 90 x 110	326	71	143	147	81	8	1815	16	11	7.4-17
4914020	125 x 90 x 125	382	86	165	161	88	5	2805	16	11	7.4-17
4914021	125 x 110 x 125	382	86	165	173	88	5	2859	16	11	7.4-17
4914022	160 x 90 x 160	396	97	209	192	105	3	4185	16	11	7.4-17
4914023	160 x 110 x 160	440	86	208	193	106	3	4470	16	11	7.4-17
4914024	160 x 125 x 160	396	97	209	214	105	3	4470	16	11	7.4-17
4914025	180 x 90 x 180	422	106	245	200	116	2	6090	16	11	7.4-17
4914026	180 x 110 x 180	422	106	245	219	116	2	6270	16	11	7.4-17
4914027	180 x 125 x 180	422	106	245	225	116	2	6410	16	11	7.4-17
4914028	180 x 140 x 180	422	106	245	237	116	1	6610	16	11	7.4-17
4914029	180 x 160 x 180	422	106	245	250	116	1	6950	16	11	7.4-17
4914030	200 x 90 x 200	451	114	261	205	125	2	7140	16	11	7.4-17
4914031	200 x 110 x 200	451	114	261	210	125	2	7235	16	11	7.4-17
4914032	225 x 90 x 225	494	122	293	220	140	1	9900	16	11	7.4-17
4914033	225 x 110 x 225	494	122	293	225	140	1	10000	16	11	7.4-17
4914034	250 x 90 x 250	538	129	326	235	152	1	13350	16	11	7.4-17
4914035	250 x 110 x 250	538	129	326	240	152	1	13400	16	11	7.4-17

*Enlarging Tee.

Two Outlets Reducing Tee

4924

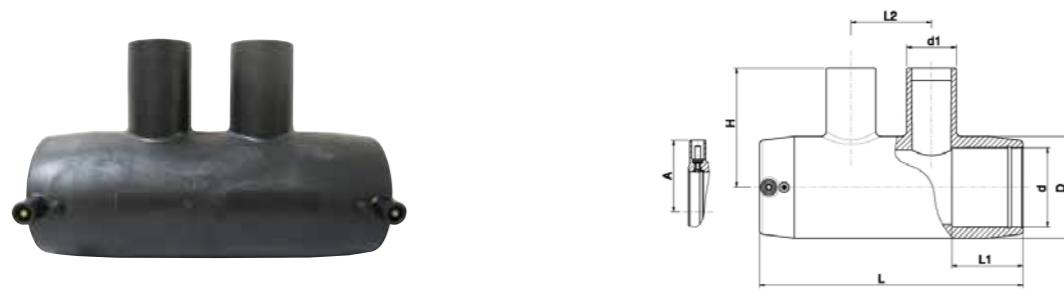

Product Code	Size d x d1 - d1 x d	L	L1	L2	D	H	A	Carton	W	PN Water	SDR Gas	Pipe SDR Suitability
4924001	40 x 25-25 x 40	176	46	57	56	72	46	96	229	16	11	7.4-11
4924002	40 x 32-32 x 40	176	46	57	56	76	46	75	233	16	11	7.4-11
4924003	50 x 25-25 x 50	195	49	65	68	79	51	56	342	16	11	7.4-11
4924004	50 x 32-32 x 50	195	49	65	68	83	51	58	336	16	11	7.4-11
4924005	50 x 40-40 x 50	195	49	65	68	89	51	52	352	16	11	7.4-11
4924006	63 x 25-25 x 63	213	58	65	82	86	57	42	457	16	11	7.4-11
4924007	63 x 32-32 x 63	213	58	65	82	90	57	40	464	16	11	7.4-11
4924008	63 x 40-40 x 63	213	58	65	82	96	57	36	480	16	11	7.4-11

Flanged Tee

4994



Flange: PP Coated Steel

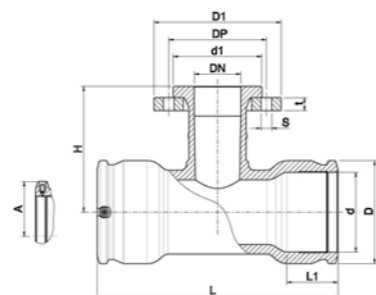

Product Code	Size d x DN x d	L	L1	D	H	A	t	S	d1	DP	Carton	W	PN Water	SDR Gas	Pipe SDR Suitability
4994008	110 x 80 x 110	326	71	143	181	81	20	8 x 18	138	160	6	3560	16	11	7.4-17
4994001	110 x 100 x 110	326	71	143	181	81	22	8 x 18	158	180	6	4240	16	11	7.4-17
4994009	125 x 80 x 125	382	86	165	190	88	20	8 x 18	138	160	4	4550	16	11	7.4-17
4994002	125 x 100 x 125	382	86	165	190	88	22	8 x 18	158	180	3	5180	16	11	7.4-17
4994010	160 x 80 x 160	440	86	208	210	106	20	8 x 18	138	160	3	6245	16	11	7.4-17
4994003	160 x 100 x 160	440	86	208	210	106	22	8 x 18	158	180	3	6785	16	11	7.4-17
4994011	180 x 80 x 180	422	106	245	225	116	20	8 x 18	138	160	2	7745	16	11	7.4-17
4994004	180 x 100 x 180	422	106	245	225	116	22	8 x 18	158	180	1	8550	16	11	7.4-17
4994005	200 x 100 x 200	451	114	261	245	125	22	8 x 18	158	180	1	9230	16	11	7.4-17
4994012	225 x 80 x 225	494	122	293	255	140	20	8 x 18	138	160	1	11240	16	11	7.4-17
4994006	225 x 100 x 225	494	122	293	260	140	22	8 x 18	158	180	1	11900	16	11	7.4-17
4994013	250 x 80 x 250	538	129	326	270	152	20	8 x 18	138	160	1	14750	16	11	7.4-17
4994007	250 x 100 x 250	538	129	326	275	152	22	8 x 18	158	180	1	15400	16	11	7.4-17

See ISO Flange dimensions and equivalent Australian Standard Flanges in the Metric section.

45° Elbow

4906

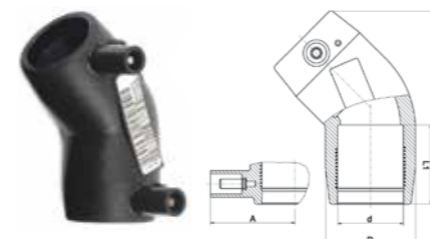

32mm up to 75mm



90mm up to 250mm

Product Code	Size d	L	L1	D	A	Carton	W	PN Water	SDR Gas	Pipe SDR Suitability
4906001	32	95	39	45	43	240	75	16	11	7.4-11
4906002	40	108	42	55	46	160	117	16	17	7.4-17
4906003	50	125	49	68	51	96	181	16	17	7.4-17
4906004	63	148	57	81	59	60	264	16	17	7.4-17
4906005	75	180	71	96	62	40	426	16	17	7.4-17
4906006	90	243	75	112	69	22	759	16	17	7.4-17
4906007	110	271	81	143	78	12	1269	16	17	7.4-17
4906008	125	304	86	165	88	8	2030	16	17	7.4-17
4906009	140	342	92	182	95	5	2471	16	17	7.4-17
4906010	160	350	95	209	105	4	3350	16	17	7.4-17
4906011	180	434	105	244	114	2	6150	16	17	7.4-17
4906012	200	472	112	261	125	1	7050	16	17	7.4-17
4906013	225	520	120	294	140	1	9800	16	21	7.4-17
4906014	250	571	129	326	151	1	13400	16	21	7.4-26

90° Elbow

4905



20mm up to 75mm



90mm up to 250mm

Product Code	Size d	L	L1	D	A	Carton	W	PN Water	SDR Gas	Pipe SDR Suitability
4905001	20	66	35	36	38	320	65	16	11	7.4-11
4905002	25	66	37	36	38	320	52	16	11	7.4-11
4905003	32	83	40	44	43	192	85	16	11	7.4-11
4905004	40	92	44	55	47	120	138	16	11	7.4-17
4905005	50	108	48	68	52	72	211	16	11	7.4-17
4905006	63	131	57	81	59	40	320	16	11	7.4-17
4905007	75	158	69	97	62	33	527	16	11	7.4-17
4905008	90	213	78	113	69	19	875	16	11	7.4-17
4905009	110	243	79	143	79	9	1519	16	11	7.4-17
4905010	125	271	100	165	89	7	2424	16	11	7.4-17
4905011	140	309	93	183	94	4	3024	16	11	7.4-17
4905012	160	323	87	209	106	3	3990	16	11	7.4-17
4905013	180	412	105	244	115	2	7590	16	11	7.4-17
4905014	200	449	112	262	124	1	8670	16	11	7.4-17
4905015	225	498	121	295	140	1	12200	16	11	7.4-21
4905016	250	550	130	327	152	1	13500	16	11	7.4-21

22.5° Elbow

4908

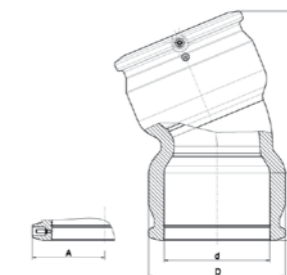

Product Code	Size d	L	L1	D	A	Carton	W	PN Water	SDR Gas	Pipe SDR Suitability
4908001	90	214	72	113	71	26	665	16	11	7.4-17
4908002	110	232	71	143	81	14	1087	16	11	7.4-17
4908003	125	274	86	165	88	8	1850	16	11	7.4-17
4908004	160	302	86	209	106	5	2930	16	11	7.4-17
4908005	180	391	105	244	115	2	5360	16	11	7.4-17

15° LightFit Elbow

4637

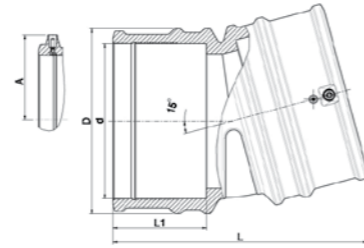

Product Code	Size d	L	L1	D	Carton	W	PN Water	SDR Gas	Pipe SDR Suitability
4637001	160	265	98	193	6	1728	10	17	17-33

30° LightFit Elbow

4633

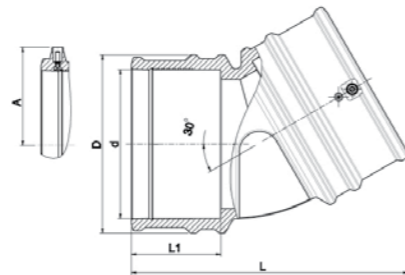

Product Code	Size d	L	L1	D	Carton	W	PN Water	SDR Gas	Pipe SDR Suitability
4633001	160	300	98	193	4	1798	10	17	17-33

45° LightFit Elbow

4706/4606

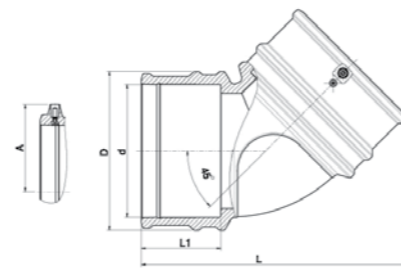

Product Code	Size d	L	L1	D	Carton	W	PN Water	SDR Gas	Pipe SDR Suitability
4706001	110	271	80	142	12	1320	10	17	11-33
4606001	160	323	98	193	4	1976	10	17	17-33

180° Elbow

4909

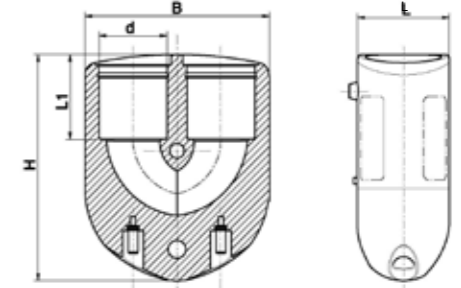

Product Code	Size d	L	L1	H	B	Carton	W	PN Water	SDR Gas	Pipe SDR Suitability
4909001	25	38	38	99	72	216	169	16	11	7.4-11
4909002	32	44	41	108	88	144	216	16	11	7.4-11
4909003	40	53	48	123	106	80	323	16	11	7.4-11

Y Reducer

4919

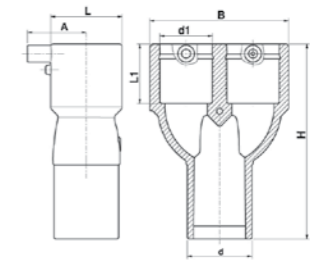

Product Code	Size d x d1 x d1	L	L1	B	A	H	Carton	W	PN Water	SDR Gas	Pipe SDR Suitability
4919001	32 x 25 x 25	36	40	70	38	119	200	97	16	11	7.4-11
4919002	40 x 32 x 32	45	43	87	42	133	120	151	16	11	7.4-11
4919003	50 x 40 x 40	56	46	108	46	151	72	260	16	11	7.4-11

Duckfoot 90° Elbow

4915

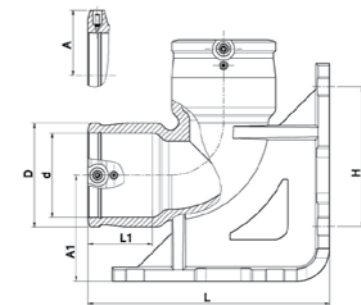

Product Code	Size d	L	L1	D	A	A1	H	Carton	W	PN Water	SDR Gas	Pipe SDR Suitability
4915001	90	261	69	112	71	115	146	5	2260	16	11	7.4-17

Duckfoot 90° Elbow With Outlet

4915

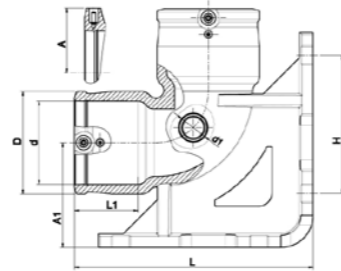

Product Code	Size d x d1	L	L1	D	A	A1	H	Carton	W	PN Water	SDR Gas	Pipe SDR Suitability
4915002	90 x 32	261	69	112	71	115	146	5	2265	16	11	7.4-17

Adjustable Elbow

4947

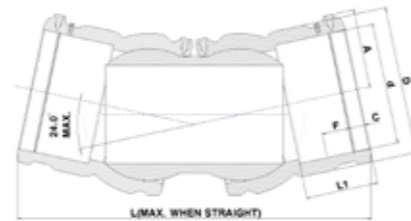

Product Code	Size d	L	L1	D	A	Carton	W	PN Water	SDR Gas	Pipe SDR Suitability
4947012	90	341	72	116	77	12	1450	16	11	7.4-17
4947001	110	362	80	140	83	8	2030	16	11	7.4-17
4947002	125	382	85	157	95	8	2630	16	11	7.4-17
4947003	160	453	97	215	106	3	4510	16	11	7.4-17
4947004	180	489	99	237	116	2	7490	16	11	7.4-17
4947005	200	512	104	250	125	2	9733	16	11	7.4-17
4947026	225	600	105	282	141	1	13230	16	11	7.4-17
4947013	250	644	123	312	156	1	16775	16	11	7.4-17

Adjustable Elbow One Sided

4947

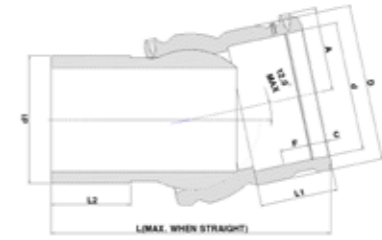

Product Code	Size d x d1	L	L1	L2	D	A	Carton	W	PN Water	SDR Gas	Pipe SDR Suitability
4947014	90 x 90	258	72	82	116	77	20	940	16	11	7.4-17
4947006	110 x 110	276	85	85	140	83	12	1290	16	11	7.4-17
4947007	125 x 125	292	90	90	157	95	12	1740	16	11	7.4-17
4947008	160 x 160	341	97	100	215	106	4	3150	16	11	7.4-17
4947009	180 x 180	370	99	145	221	128	3	4210	16	11	7.4-17
4947010	200 x 200	370	104	116	250	125	2	6172	16	11	7.4-17
4947011	225 x 225	426	105	124	282	141	2	8340	16	11	7.4-17
4947015	250 x 250	455	123	134	312	156	1	10800	16	11	7.4-17

Saddle Female Threaded Outlet

4958

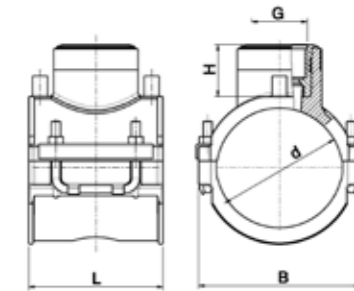

Product Code	Size d x Rp	B	H	L	Carton	W	PN Water	SDR Gas	Pipe SDR Suitability
4958055	63 x 1"	100	30	118	60	390	16	11	7.4-11
4958056	63 x 1 1/4"	100	30	118	60	400	16	11	7.4-11
4958057	63 x 1 1/2"	100	30	118	60	400	16	11	7.4-11
4958167	90 x 1"	126	30	118	36	520	16	11	7.4-11

PE100 female threaded outlet.

Repair Saddle with Underpart

4952

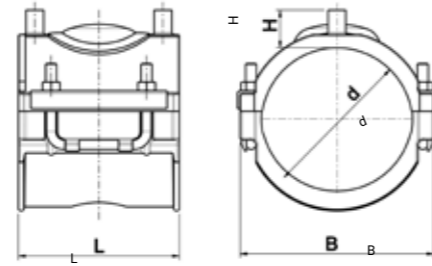

Product Code	Size d	B	H	L	Max Damage Length	Carton	W	PN Water	SDR Gas	Pipe SDR Suitability
4952001	63	100	29	118	38	72	378	16	11	7.4-11
4952002	75	117	29	118	38	48	410	16	11	7.4-11
4952003	90	126	29	118	38	40	504	16	11	7.4-17
4952004	110	148	29	118	38	32	555	16	11	7.4-17
4952005	125	162	29	118	38	24	620	16	11	7.4-17
4952006	140	180	29	118	38	24	660	16	11	7.4-17
4952007	160	199	29	118	38	24	718	16	11	7.4-17
4952008	180	219	29	118	38	16	759	16	11	7.4-17

Double Repair Saddle

4952

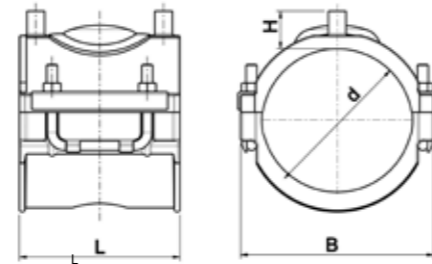

Product Code	Size d	B	H	L	Max Damage Length	Carton	W	PN Water	SDR Gas	Pipe SDR Suitability
4952009	63	100	29	118	38	72	378	16	11	7.4-11
4952010	90	126	29	118	38	40	504	16	11	7.4-17
4952011	110	148	29	118	38	32	555	16	11	7.4-17
4952012	160	199	29	118	38	24	788	16	11	7.4-17
4952013	200	202	29	176	38	15	1486	16	11	7.4-17

Repair Saddle

4952

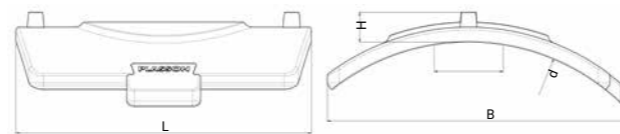

Product Code	Size d	B	H	L	Max Damage Length	Carton	W	PN Water	SDR Gas	Pipe SDR Suitability
4952014	250-900	305	30	300	70	24	1500	16	11	7.4-17
4952015	400-900	471	43	610	230	1	6900	16	11	7.4-21

See tooling section for dedicated tools.

Transition Saddle

4938



63mm up to 180mm
Outlets 1 1/4" and 1 1/2"



90mm up to 250mm
Outlet: 2"

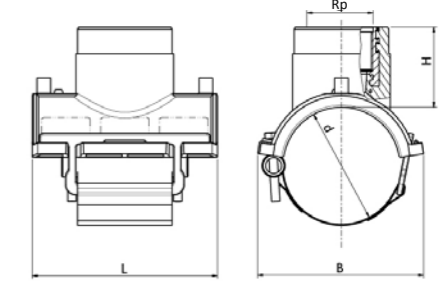

Product Code	Size d x Rp	B	H	L	Carton	W	PN Water	SDR Gas	Pipe SDR Suitability
4938001	63 x 1 1/4"	100	53	118	48	612	16	11	7.4-11
4938002	75 x 1 1/4"	117	53	118	40	656	16	11	7.4-11
4938003	90 x 1 1/2"	121	53	118	16	930	16	11	7.4-17
4938004	90 x 2"	142	76	176	14	1436	16	11	7.4-17
4938006	110 x 1 1/2"	142	53	118	12	1006	16	11	7.4-17
4938007	110 x 2"	158	76	176	12	1500	16	11	7.4-17
4938009	125 x 1 1/2"	158	53	118	12	1049	16	11	7.4-17
4938010	125 x 2"	166	76	176	12	1510	16	11	7.4-17
4938011	140 x 1 1/2"	175	53	118	10	1072	16	11	7.4-17
4938012	140 x 2"	174	76	176	10	1520	16	11	7.4-17
4938013	160 x 1 1/2"	196	53	118	8	1163	16	11	7.4-17
4938014	160 x 2"	176	76	176	10	1540	16	11	7.4-17
4938016	180 x 1 1/2"	216	53	118	6	1200	16	11	7.4-17
4938017	180 x 2"	182	76	176	10	1500	16	11	7.4-17
4938018	200 x 2"	202	76	176	10	1575	16	11	7.4-17
4938019	225 x 2"	227	76	176	10	1570	16	11	7.4-17
4938020	250 x 2"	252	76	176	10	1040	16	11	7.4-17

Large Bore Transition Saddle

4938

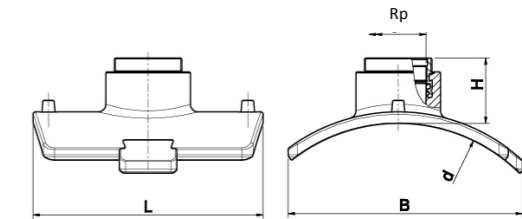

Product Code	Size d x Rp	B	H	L	Carton	W	PN Water	SDR Gas	Pipe SDR Suitability
4938021	250-400 x 2"	305	77	306	8	1975	16	11	7.4-17
4938022	450-800 x 2"	315	77	306	8	1960	16	11	7.4-26

See tooling section for dedicated tools.

Sensor Saddle with a S/S Thread

4938

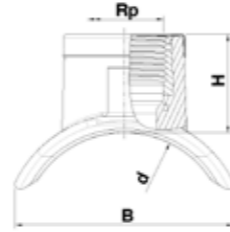
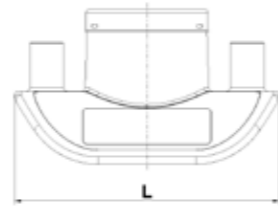

Product Code	Size d x Rp	H	B	L	Carton	W	PN Water	SDR Gas
4938101	110-400 x 1/2"	35	85	103	140	109.3	16	11
4938102	110-400 x 3/4"	38	85	103	140	120	16	11
4938103	110-400 x 1"	38	85	103	140	148.3	16	11
4938104	450-1200 x 1/2"	35	85	103	140	109.3	16	11
4938105	450-1200 x 3/4"	38	85	103	140	120	16	11
4938106	450-1200 x 1"	38	85	103	140	148.3	16	11

See tooling section for dedicated tools.

Pipe Size	Pipe SDR Suitability
110 - 225	7.4 - 11
250 - 280	7.4 - 17.6
315 - 355	7.4 - 21
400+	7.4 - 26

Branch Saddle

4958



63mm up to 180mm
Outlets 32mm to 63mm



200mm up to 315mm
and all sizes with Outlet 90mm

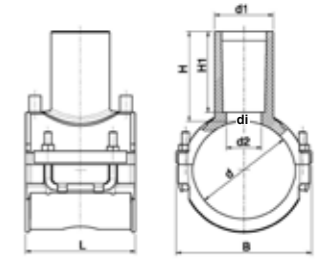

Product Code	Size d x d1	B	H1	LS	L	di	Carton	W	PN Water	SDR Gas	Pipe SDR Suitability
4958001	63 x 32	100	59	49	118	23	56	394	16	11	7.4-11
4958002	63 x 40	100	78	66	118	29.5	40	400	16	11	7.4-11
4958003	63 x 50	100	93	82	118	37.5	40	430	16	11	7.4-11
4958004	63 x 63	100	94	85	118	45	40	462	16	11	7.4-11
4958005	75 x 32	117	59	49	118	23	48	431	16	11	7.4-11
4958006	75 x 40	117	78	66	118	29.5	36	451	16	11	7.4-11
4958007	75 x 50	117	93	82	118	37.5	32	465	16	11	7.4-11
4958008	75 x 63	117	94	85	118	45	32	522	16	11	7.4-11
4958009	90 x 32	126	59	49	118	23	32	519	16	11	7.4-17
4958010	90 x 40	126	78	68	118	29.5	32	529	16	11	7.4-17
4958011	90 x 50	126	93	82	118	37.5	32	550	16	11	7.4-17
4958012	90 x 63	126	94	85	118	45	24	608	16	11	7.4-17
4958013	90 x 90	139	105	90	176	66	15	934	16	11	7.4-17
4958014	110 x 32	148	59	49	118	23	24	585	16	11	7.4-17
4958015	110 x 40	148	78	68	118	29.5	24	598	16	11	7.4-17
4958016	110 x 50	148	93	82	118	37.5	20	629	16	11	7.4-17
4958017	110 x 63	148	94	85	118	45	20	658	16	11	7.4-17
4958018	110 x 90	162	105	90	176	68	18	949	16	11	7.4-17
4958019	125 x 32	162	59	49	118	23	24	634	16	11	7.4-17
4958020	125 x 40	162	78	68	118	29.5	20	644	16	11	7.4-17
4958021	125 x 50	162	93	82	118	37.5	20	670	16	11	7.4-17
4958022	125 x 63	162	94	85	118	45	16	703	16	11	7.4-17
4958023	125 x 90	169	105	90	176	68	18	953	16	11	7.4-17
4958024	140 x 32	180	59	49	118	23	24	661	16	11	7.4-17
4958025	140 x 40	180	78	68	118	29.5	16	677	16	11	7.4-17
4958026	140 x 50	180	93	82	118	37.5	16	705	16	11	7.4-17
4958027	140 x 63	180	94	85	118	45	16	740	16	11	7.4-17
4958028	140 x 90	174	105	90	176	68	16	965	16	11	7.4-17
4958029	160 x 32	200	59	49	118	23	16	744	16	11	7.4-17
4958030	160 x 40	200	78	68	118	29.5	16	757	16	11	7.4-17
4958031	160 x 50	200	93	82	118	37.5	16	778	16	11	7.4-17
4958032	160 x 63	200	94	85	118	45	16	804	16	11	7.4-17
4958033	160 x 90	176	105	90	176	68	16	961	16	11	7.4-17
4958034	180 x 32	219	59	49	118	23	16	800	16	11	7.4-17
4958035	180 x 40	219	78	68	118	29.5	12	800	16	11	7.4-17
4958036	180 x 50	219	93	82	118	37.5	12	828	16	11	7.4-17
4958037	180 x 63	219	94	85	118	45	12	886	16	11	7.4-17
4958038	180 x 90	182	105	90	176	68	15	962	16	11	7.4-17
4958039	200 x 63	202	102	85	176	47	15	862	16	11	7.4-17
4958040	200 x 90	202	105	90	176	68	15	900	16	11	7.4-17
4958041	225 x 63	227	102	85	176	47	15	882	16	11	7.4-17
4958042	225 x 90	227	105	90	176	68	15	983	16	11	7.4-17
4958043	250 x 63	252	102	85	176	47	15	970	16	11	7.4-17
4958044	250 x 90	252	105	90	176	68	15	1070	16	11	7.4-17
4958045	280 x 90	282	105	90	176	68	10	990	16	11	7.4-17
4958046	315 x 90	317	105	90	176	68	15	1005	16	11	7.4-17

Branch Saddle with Red Wire Underpart & Test Spigot

4958

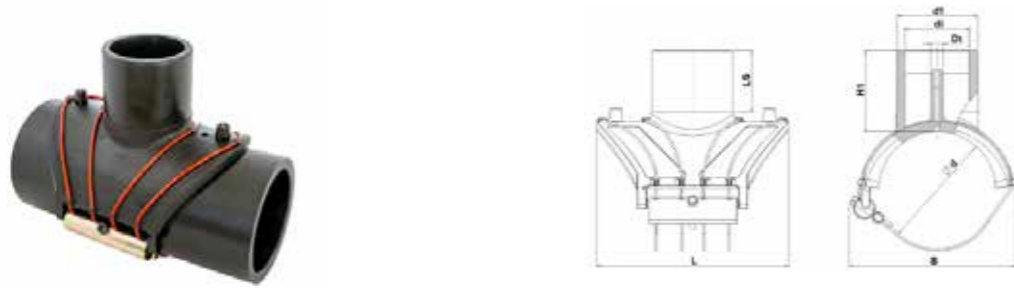

Product Code	Size d x d1	B	H1	LS	L	di	Dt	Carton	W	PN Water	SDR Gas	Pipe SDR Suitability
4958168	125 x 90	180	106	81	242	73	16	9	890	16	11	7.4-17
4958154	125 x 110	180	109	84	242	89	16	9	1004	16	11	7.4-17
4958169	140 x 90	189	106	81	242	73	16	9	830	16	11	7.4-17
4958155	140 x 110	189	109	84	242	89	16	9	901	16	11	7.4-17
4958170	160 x 90	222	107	81	263	73	16	6	1330	16	11	7.4-17
4958156	160 x 110	222	110	84	263	89	16	6	1020	16	11	7.4-17
4958171	180 x 90	229	107	81	263	73	16	6	1480	16	11	7.4-17
4958157	180 x 110	229	110	84	263	89	16	6	1140	16	11	7.4-17
4958178	180 x 125	249	156	338	141	102	16	4	-	16	11	7.4-17
4958175	180 x 160	249	167	338	152	131	16	4	-	16	11	7.4-17
4958172	200 x 90	277	109	81	295	73	16	6	1960	16	11	7.4-17
4958158	200 x 110	277	111	84	295	89	16	6	1630	16	11	7.4-17
4958179	200 x 125	249	156	338	141	102	16	4	-	16	11	7.4-17
4958176	200 x 160	249	167	338	152	131	16	4	-	16	11	7.4-17
4958173	225 x 90	277	109	81	295	73	16	6	1800	16	11	7.4-17
4958159	225 x 110	277	112	85	295	89	16	6	1500	16	11	7.4-17
4958180	225 x 125	291	156	338	141	102	16	4	-	16	11	7.4-17
4958177	225 x 160	291	167	338	152	131	16	4	-	16	11	7.4-17
4958174	250 x 90	280	109	81	295	73	16	6	1650	16	11	7.4-17
4958160	250 x 110	280	111	84	295	89	16	6	1310	16	11	7.4-17
4958181	250 x 125	291	156	338	141	102	16	4	-	16	11	7.4-17
4958182	250 x 160	291	167	152	338	131	16	4	-	16	11	7.4-17

Large Bore Branch Saddle

4958

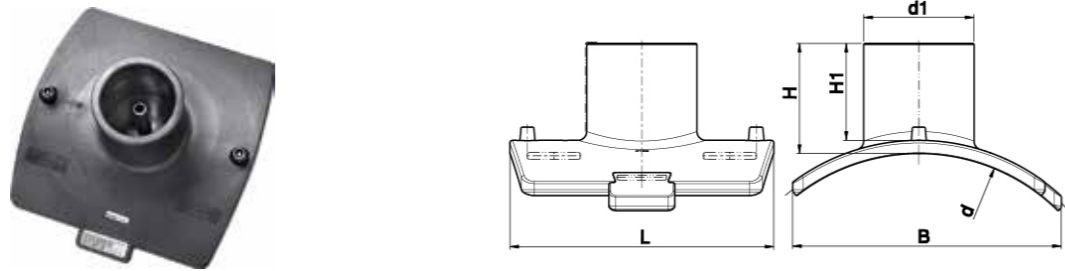

Product Code	Size d x d1	B	di	LS	Dt	H1	L	Carton	W	PN Water	SDR Gas	Pipe SDR Suitability
4958047	280 - 400 x 90	305	73	102	16	115	300	7	1510	16	11	7.4-17
4958048	280 - 400 x 110	305	90	104	16	117	300	7	1650	16	11	7.4-17
4958049	280 - 400 x 125	305	102	119	16	110	300	6	1760	16	11	7.4-17
4958050	280 - 400 x 160	305	131	119	16	132	300	6	2167	16	11	7.4-21
4958051	450 - 800 x 90	315	73	105	16	117	300	7	1598	16	11	7.4-26
4958052	450 - 800 x 110	315	90	105	16	117	300	7	1601	16	11	7.4-26
4958053	450 - 800 x 125	315	102	109	16	117	300	7	1739	16	11	7.4-26
4958054	450 - 800 x 160	315	131	115	16	130	300	6	2017	16	11	7.4-26

XL & XXL Branch Saddle

4958

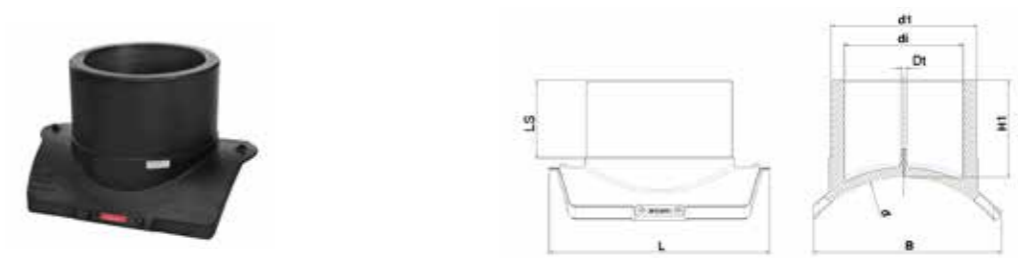

Product Code	d x d1	B	L	di	LS	H1	Dt	Carton	W	PN Water	SDR Gas	Pipe SDR Suitability
4758092	315-355 x 250	390	420	204	140	200	16	1	7400	16	11	11-17
4958163	400-450 x 200	387	470	164	142	180	16	1	6000	16	11	11-21
4958164	400-450 x 225	390	470	184	150	189	16	1	6300	16	11	11-21
4958183	400-450 x 250	405	470	205	160	195	16	1	7900	16	11	11-21
4958116	450 x 280	450	530	230	169	225	16	1	10900	16	11	11-26
4958094	450 x 315	450	530	259	180	220	16	1	13000	16	11	11-26
4958117	500 x 280	465	530	230	169	225	16	1	10800	16	11	11-26
4958095	500 x 315	480	540	259	180	227	16	1	13500	16	11	11-26
4958118	500 x 355	500	610	292	194	252	16	1	17670	16	11	11-26
4958083	500 - 630 x 250	400	420	205	203	225	16	1	6670	16	11	11-33
4958165	500 - 630 x 200	425	470	164	160	185	16	1	5300	16	11	11-26
4958166	500 - 630 x 225	425	420	184	203	225	16	1	5900	16	11	11-26
4958119	560 x 280	477	530	230	169	225	16	1	10700	16	11	11-26
4958096	560 x 315	472	540	259	180	227	16	1	12800	16	11	11-26
4958120	560 x 355	512	610	292	194	252	16	1	17200	16	10	11-26
4958084	560 x 400	505	620	329	209	258	16	1	20100	16	11	11-26
4958121	630 x 280	489	530	230	169	225	16	1	10700	16	11	11-33
4958097	630 x 315	481	540	259	180	227	16	1	12700	16	11	11-33
4958122	630 x 355	522	610	292	194	252	16	1	16700	16	11	11-33
4958085	630 x 400	520	620	329	209	258	16	1	20400	16	11	11-33
4958111	710 x 200	410	470	164	142	180	16	1	5400	16	11	11-41
4958112	710 x 225	410	470	184	150	187	16	1	6400	16	11	11-41
4958098	710 x 250	430	470	205	160	195	16	1	7500	16	11	11-41
4958123	710 x 280	498	530	230	169	225	16	1	10600	16	11	11-41
4958099	710 x 315	500	530	259	180	220	16	1	12600	16	11	11-41
4958124	710 x 355	532	610	292	194	252	16	1	17200	16	11	11-41
4958100	710 x 400	530	610	329	209	250	16	1	19000	16	11	11-41
4958113	800 x 200	410	470	164	142	180	16	1	5500	16	11	11-41
4958114	800 x 225	415	470	184	150	189	16	1	6200	16	11	11-41
4958101	800 x 250	430	470	205	160	197	16	1	7500	16	11	11-41
4958125	800 x 280	505	530	259	169	225	16	1	10600	16	11	11-26
4958102	800 x 315	510	530	292	180	220	16	1	12200	16	11	11-41
4958126	800 x 355	543	610	329	194	252	16	1	16500	16	11	11-41
4958103	800 x 400	540	610	329	209	250	16	1	20000	16	11	11-41
4958088	900 x 110	320	300	73	105	123	16	6	1900	16	11	11-41
4958089	900 x 125	320	300	101	110	130	16	6	2100	16	11	11-41
4958090	900 x 160	295	300	131	113	131	16	6	2390	16	11	11-41
4958151	900 x 180	435	470	147	135	169	16	1	4600	16	11	11-41
4958152	900 x 200	415	470	164	142	180	16	1	5300	16	11	11-41
4958153	900 x 225	415	470	184	150	189	16	1	6500	16	11	11-41
4958087	900 x 250	440	470	204	160	197	16	1	7000	16	11	11-41
4958127	900 x 280	511	530	230	169	225	16	1	10600	16	11	11-41
4958104	900 x 315	510	530	259	180	220	16	1	12100	16	11	11-41
4958128	900 x 355	554	610	292	194	252	16	1	17200	16	11	11-41
4958091	900 x 400	550	610	329	209	250	16	1	19130	16	11	11-41

See tooling section for dedicated tools.

XL & XXL Branch Saddle Cont.

4958

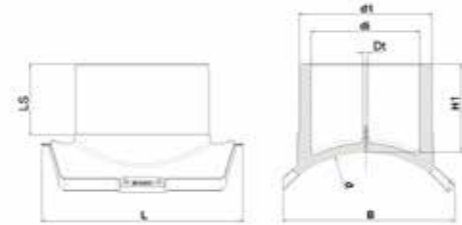

Product Code	d x d1	B	L	di	LS	H1	Dt	Carton	W	PN Water	SDR Gas	Pipe SDR Suitability
4958145	1000 x 110	295	300	73	97	115	16	6	2000	16	11	11-41
4958146	1000 x 125	295	300	102	102	120	16	6	2200	16	11	11-41
4958147	1000 x 160	295	300	131	113	131	16	6	3000	16	11	11-41
4958129	1000 x 180	443	470	147	166	184	16	1	4600	16	11	11-41
4958130	1000 x 200	443	470	163	176	198	16	1	5300	16	11	11-41
4958131	1000 x 225	443	470	184	181	203	16	1	6500	16	11	11-41
4958132	1000 x 250	443	470	205	190	213	16	1	7360	16	11	11-41
4958133	1000 x 280	516	530	230	169	225	16	1	10500	16	11	11-41
4958134	1000 x 315	516	530	259	211	236	16	1	12320	16	11	11-41
4958135	1000 x 355	563	610	292	194	252	16	1	16830	16	11	11-41
4958136	1000 x 400	563	610	329	240	267	16	1	20000	16	11	11-41
4958148	1200 x 110	295	300	73	97	115	16	6	2000	16	11	11-41
4958149	1200 x 125	395	300	102	102	120	16	6	2200	16	11	11-41
4958150	1200 x 160	295	300	131	113	131	16	6	2500	16	11	11-41
4958137	1200 x 180	447	470	147	166	184	16	1	4700	16	11	11-41
4958138	1200 x 200	447	470	163	176	198	16	1	5740	16	11	11-41
4958139	1200 x 225	447	470	184	181	189	16	1	6350	16	11	11-41
4958140	1200 x 250	447	470	204	190	213	16	1	7370	16	11	11-41
4958141	1200 x 280	527	530	230	169	225	16	1	10500	16	11	11-41
4958142	1200 x 315	526	530	257	211	236	16	1	12000	16	11	11-41
4958143	1200 x 355	575	610	252	194	252	16	1	16500	16	11	11-41
4958144	1200 x 400	574	610	327	240	267	16	1	20000	16	11	11-41

See tooling section for dedicated tools.

LightFit Branch Saddle

4758

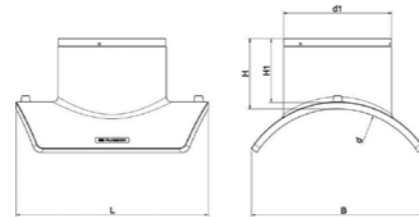

Product Code	d x d1	B	L	H1	H	Carton	W	PN Water	SDR Gas	Pipe SDR Suitability
4758028	315 - 450 x 225	359	145	130	400	1	3800	10	17	17-33
4758029	450 - 630 x 225	389	145	130	400	1	3760	10	17	17-33
4758030	630 - 800 x 225	407	145	130	400	1	3835	10	17	17-33

See tooling section for dedicated tools.

High Volume Tapping Tee (HVTT)

4913

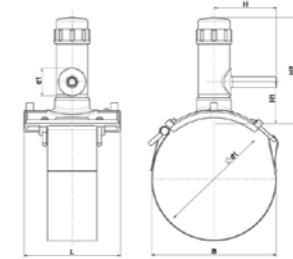

Product Code	size d x d1	B	L	H	H1	H2	PN Water	SDR Gas	Pipe SDR Suitability
4913001	90 x 63	139	176	130	75	195	16	11	7.4-17
4913002	110 x 63	156	176	130	75	195	16	11	7.4-17
4913003	125 x 63	165	176	130	75	195	16	11	7.4-17
4913004	140 x 63	171	176	130	75	195	16	11	7.4-17
4913005	160 x 63	173	176	130	75	195	16	11	7.4-17
4913006	180 x 63	176	176	130	75	195	16	11	7.4-17
4913007	200 x 63	178	176	130	75	195	16	11	7.4-17
4913008	225 x 63	180	176	130	75	195	16	11	7.4-17
4913009	250 x 63	180	176	130	75	195	16	11	7.4-17
4913010	280 x 63	180	176	130	75	195	16	11	7.4-17
4913011	315 x 63	183	176	130	75	195	16	11	7.4-17

Integrated core cutter with 47mm core.

Hex Key

2013



Product Code	Size
2013001	12 x 200mm

The Plasson Hex Key is designed for use with all Plasson tapping saddles. It comes with a 12mm square drive connection. Wrench not included. Cut hole after 4x the cooling period indicated on the fitting label.

Tapping Saddle

4963

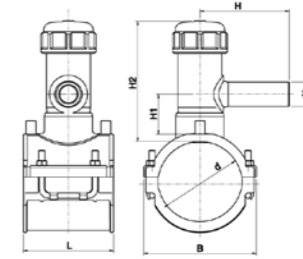
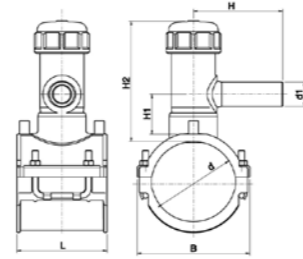

Product Code	Size d x d1	H	B	H1	H2	L	Welding Cap Type	Core Cutter Size	Carton	W	PN Water	SDR Gas	Pipe SDR Suitability
4963001	40 x 20	107	66	7	94	100	Type C	20	52	290	16	11	7.4-11
4963064	40 x 25	90	65	7	98	100	Type C	20	52	349	16	11	7.4-11
4963002	40 x 32	121	66	11	94	100	Type C	20	52	370	16	11	7.4-11
4963003	50 x 20	110	76	7	98	100	Type C	20	52	390	16	11	7.4-11
4963004	50 x 25	91	76	10	98	100	Type C	20	50	390	16	11	7.4-11
4963005	50 x 32	122	76	12	98	100	Type C	20	45	390	16	11	7.4-11
4963006	63 x 20	90	100	10	90	118	Type C	20	40	362	16	11	7.4-11
4963007	63 x 25	93	100	12	36	118	Type C	20	40	364	16	11	7.4-11
4963008	63 x 32	99	100	12	90	118	Type C	20	40	380	16	11	7.4-11
4963009	63 x 40	142	100	64	177	118	Type A	20	16	870	16	11	7.4-11
4963010	63 x 50	154	100	64	177	118	Type A	20	16	1099	16	11	7.4-11
4963011	63 x 63	175	100	64	177	118	Type A	20	16	962	16	11	7.4-11
4963012	75 x 20	125	117	50	177	118	Type A	20	16	1120	16	11	7.4-11
4963013	75 x 32	132	117	56	177	118	Type A	30	16	1091	16	11	7.4-11
4963014	75 x 40	142	117	60	177	118	Type A	30	16	1124	16	11	7.4-11
4963015	75 x 50	123	117	64	177	118	Type A	30	16	1140	16	11	7.4-11
4963016	75 x 63	175	117	64	177	118	Type A	30	16	1228	16	11	7.4-11
4963017	90 x 20	117	126	16	114	118	Type B	25	20	900	16	11	7.4-17
4963018	90 x 25	108	126	16	114	118	Type B	25	20	1120	16	11	7.4-17
4963019	90 x 32	126	126	16	114	118	Type B	25	20	778	16	11	7.4-17
4963020	90 x 40	134	126	21	114	118	Type B	25	20	1130	16	11	7.4-17
4963021	90 x 50	123	126	64	177	118	Type A	30	14	1220	16	11	7.4-17
4963022	90 x 63	175	126	64	177	118	Type A	30	14	1300	16	11	7.4-17
4963023	110 x 20	119	148	16	114	118	Type B	25	20	964	16	11	7.4-17
4963068	110 x 25	118	148	16	114	118	Type B	30	20	830	16	11	7.4-17
4963024	110 x 32	127	148	16	114	118	Type B	25	20	846	16	11	7.4-17
4963025	110 x 40	138	148	21	114	118	Type B	25	20	1000	16	11	7.4-17
4963026	110 x 50	123	148	64	177	118	Type A	30	12	1300	16	11	7.4-17
4963027	110 x 63	175	148	64	177	118	Type A	30	12	1383	16	11	7.4-17
4963028	125 x 20	116	162	16	114	118	Type B	25	15	1220	16	11	7.4-17
4963067	125 x 25	95	162	16	114	118	Type B	25	15	880	16	11	7.4-17
4963029	125 x 32	131	162	16	114	118	Type B	25	15	899	16	11	7.4-17
4963030	125 x 40	141	162	21	114	118	Type B	25	15	1280	16	11	7.4-17
4963031	125 x 50	123	162	64	177	118	Type A	30	12	1345	16	11	7.4-17
4963032	125 x 63	175	162	64	177	118	Type A	30	12	1426	16	11	7.4-17
4963033	140 x 20	125	180	50	177	118	Type A	25	12	1340	16	11	7.4-17
4963034	140 x 32	132	180	56	177	118	Type A	25	12	1330	16	11	7.4-17
4963035	140 x 40	142	180	60	177	118	Type A	25	12	1360	16	11	7.4-17
4963036	140 x 50	123	180	64	177	118	Type A	30	12	1382	16	11	7.4-17
4963037	140 x 63	175	180	64	177	118	Type A	30	12	1468	16	11	7.4-17
4963038	160 x 20	118	199	21	138	118	Type A	30	10	1360	16	11	7.4-17
4963066	160 x 25	100	199	21	138	118	Type A	30	10	1170	16	11	7.4-17
4963039	160 x 32	144	199	16	138	118	Type A	30	10	1320	16	11	7.4-17
4963040	160 x 40	157	199	21	138	118	Type A	30	10	1216	16	11	7.4-17
4963041	160 x 50	175	199	24	138	118	Type A	30	10	1375	16	11	7.4-17
4963042	160 x 63	197	199	20	138	118	Type A	30	10	1390	16	11	7.4-17
4963043	180 x 20	125	219	50	177	118	Type A	30	10	1550	16	11	7.4-17
4963065	180 x 25	110	219	18	138	118	Type A	30	10	1100	16	11	7.4-17

Product Code	Size d x d1	H	B	H1	H2	L	Welding Cap Type	Core Cutter Size	Carton	W	PN Water	SDR Gas	Pipe SDR Suitability
4963044	180 x 32	144	219	18	138	118	Type A	30	10	1565	16	11	7.4-17
4963045	180 x 40	155	219	21	138	118	Type A	30	10	1274	16	11	7.4-17
4963046	180 x 50	174	219	24	138	118	Type A	30	10	1595	16	11	7.4-17
4963047	180 x 63	197	219	20	138	118	Type A	30	10	1605	16	11	7.4-17
4963048	200 x 20	125	202	50	177	176	Type A	30	8	1425	16	11	7.4-17
4963049	200 x 32	132	202	56	177	176	Type A	30	8	1451	16	11	7.4-17
4963050	200 x 40	142	202	60	177	176	Type A	30	8	1471	16	11	7.4-17
4963051	200 x 50	123	202	64	177	176	Type A	30	8	1496	16	11	7.4-17
4963052	200 x 63	175	202	64	177	176	Type A	30	8	1579	16	11	7.4-17
4963053	225 x 20	125	227	50	177	176	Type A	30	8	1370	16	11	7.4-17
4963054	225 x 32	132	227	56	177	176	Type A	30	8	1450	16	11	7.4-17
4963055	225 x 40	142	227	60	177	176	Type A	30	8	1485	16	11	7.4-17
4963056	225 x 50	123	227	64	177	176	Type A	30	8	1506	16	11	7.4-17
4963057	225 x 63	175	227	64	177	176	Type A	30	8	1589	16	11	7.4-17
4963058	250 x 20	125	252	50	177	176	Type A	30	8	1455	16	11	7.4-17
4963059	250 x 32	132	252	56	177	176	Type A	30	8	1464	16	11	7.4-17
4963060	250 x 40	142	252	60	177	176	Type A	30	8	1582	16	11	7.4-17
4963061	250 x 50	123	252	64	177	176	Type A	30	8	1589	16	11	7.4-17
4963062	250 x 63	175	252	64	177	176	Type A	30	8	1386	16	11	7.4-17

A Welding Cap can be permanently fixed to the Tapping Saddle via the electrofusion process. This prevents any accidental disassembly which can occur with the standard cap. See next page for welding cap.

Welding Cap for Tapping Saddle

4983

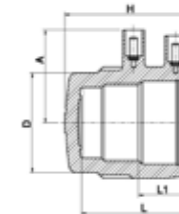

Product Code	Type	Size	D	A	H	L	L1	Carton	W	PN Water	SDR Gas
4983003	Type A	57	51	49	63	55	26	256	73	16	11
4983002	Type B	50	62	54	73	66	30	192	111	16	11
4983001	Type C	40	74	59	74	63	36	128	157	16	11

Tapping Valve

4954



63mm up to 180mm



200mm up to 250mm

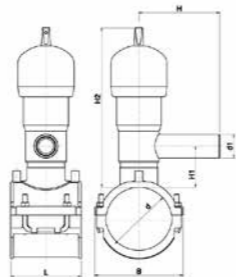

Product Code	Size d x d1	B	H	H1	H2	L	Carton	W	PN Water	SDR Gas	Pipe SDR Suitability
4954001	63 x 32	99	126	46	244	118	8	2090	16	11	7.4-11
4954002	63 x 40	99	137	46	244	118	8	2103	16	11	7.4-11
4954003	63 x 50	99	152	51	244	118	8	2140	16	11	7.4-11
4954004	63 x 63	99	186	51	244	118	8	2205	16	11	7.4-11
4954005	75 x 32	117	126	46	244	118	8	2100	16	11	7.4-11
4954006	75 x 40	117	137	46	244	118	8	2113	16	11	7.4-11
4954007	75 x 50	117	152	51	244	118	8	2150	16	11	7.4-11
4954008	75 x 63	117	186	51	244	118	8	2215	16	11	7.4-11
4954009	90 x 32	126	126	46	244	118	8	2150	16	11	7.4-11
4954010	90 x 40	126	137	46	244	118	8	2163	16	11	7.4-11
4954011	90 x 50	126	152	51	244	118	8	2200	16	11	7.4-11
4954012	90 x 63	126	186	51	244	118	8	2265	16	11	7.4-11
4954013	110 x 32	148	126	46	244	118	8	2267	16	11	11-17
4954014	110 x 40	148	137	46	244	118	8	2250	16	11	11-17
4954015	110 x 50	148	152	51	244	118	8	2280	16	11	11-17
4954016	110 x 63	148	186	51	244	118	8	2345	16	11	11-17
4954017	125 x 32	162	126	46	244	118	8	2277	16	11	11-17
4954018	125 x 40	162	137	46	244	118	8	2290	16	11	11-17
4954019	125 x 50	162	152	51	244	118	8	2327	16	11	11-17
4954020	125 x 63	162	186	51	244	118	8	2392	16	11	11-17
4954021	140 x 32	180	126	46	244	118	8	2285	16	11	11-17
4954022	140 x 40	180	137	46	244	118	8	2298	16	11	11-17
4954023	140 x 50	180	152	51	244	118	8	2335	16	11	11-17
4954024	140 x 63	180	186	51	244	118	8	2441	16	11	11-17
4954025	160 x 32	202	126	46	244	118	8	2377	16	11	11-17
4954026	160 x 40	202	137	46	244	118	8	2390	16	11	11-17
4954027	160 x 50	202	152	51	244	118	8	2427	16	11	11-17
4954028	160 x 63	202	186	51	244	118	8	2492	16	11	11-17
4954029	180 x 32	220	126	46	244	118	8	2440	16	11	11-17
4954030	180 x 40	220	137	46	244	118	8	2453	16	11	11-17
4954031	180 x 50	220	152	51	244	118	8	2490	16	11	11-17
4954032	180 x 63	220	186	51	244	118	8	2555	16	11	11-17
4954033	200 x 32	202	126	46	244	176	5	2431	16	11	11-17
4954034	200 x 40	202	137	46	244	176	5	2444	16	11	11-17
4954035	200 x 50	202	152	51	244	176	5	2481	16	11	11-17
4954036	200 x 63	202	186	51	244	176	5	2546	16	11	11-17
4954037	225 x 32	227	126	46	244	176	5	2448	16	11	11-17
4954038	225 x 40	227	137	46	244	176	5	2501	16	11	11-17
4954039	225 x 50	227	152	51	244	176	5	2538	16	11	11-17
4954040	225 x 63	227	186	51	244	176	5	2603	16	11	11-17
4954041	250 x 32	252	126	46	244	176	5	2504	16	11	11-17
4954042	250 x 40	252	137	46	244	176	5	2517	16	11	11-17
4954043	250 x 50	252	152	51	244	176	5	2554	16	11	11-17
4954044	250 x 63	252	186	51	244	176	5	2619	16	11	11-17

Male Transition Coupler

4921



Type A

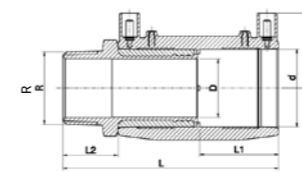

Type B



Product Code	Size d x R	Type	L	L1	L2	D	A	Carton	W	PN Water	SDR Gas	Pipe SDR Suitability
4921021	20 x 1/2"	A	105	37	29	14	34	200	129	16	11	7.4-11
4921066	20 x 3/4"	A	100	35	29	19	39	150	158	16	11	7.4-11
4921022	25 x 3/4"	A	111	40	29	19	37	150	150	16	11	7.4-11
4921064	25 x 1"	B	131	35	50	22	43	100	265	16	11	7.4-11
4921023	32 x 1/2"	A	110	39	29	23	42	100	142	16	11	7.4-11
4921024	32 x 3/4"	A	110	39	29	23	42	100	263	16	11	7.4-11
4921025	32 x 1"	B	140	44	50	22	43	100	285	16	11	7.4-11
4921026	32 x 1 1/4"	A	124	42	36	23	42	60	393	16	11	7.4-11
4921027	32 x 1 1/2"	A	124	42	36	23	42	60	404	16	11	7.4-11
4921028	40 x 1"	B	143	48	45	22	46	72	409	16	11	7.4-11
4921029	40 x 1 1/4"	B	153	48	55	30	46	54	470	16	11	7.4-11
4921030	40 x 1 1/2"	A	133	47	36	29	46	54	483	16	11	7.4-11
4921031	40 x 2"	A	160	44	41	29	59	36	500	16	11	7.4-11
4921032	50 x 1"	A	135	49	34	38	51	48	513	16	11	7.4-11
4921033	50 x 1 1/4"	A	137	49	36	38	51	48	569	16	11	7.4-11
4921034	50 x 1 1/2"	B	164	49	63	35	51	48	547	16	11	7.4-11
4921035	50 x 2"	A	160	49	41	38	59	30	752	16	11	7.4-11
4921036	63 x 1 1/4"	A	153	57	36	48	57	30	884	16	11	7.4-11
4921037	63 x 1 1/2"	A	153	57	36	48	57	30	845	16	11	7.4-11
4921038	63 x 2"	B	186	57	69	47	58	30	921	16	11	7.4-17
4921065	63 x 2 1/2"	A	172	57	46	59	66	16	1008	16	11	7.4-17
4921039	75 x 2"	A	167	61	41	59	64	16	1305	16	11	7.4-17
4921040	75 x 2 1/2"	A	172	61	46	59	64	16	1512	16	11	7.4-17
4921062	90 x 2"	B	212	71	69	47	78	8	1167	16	11	7.4-17
4921061	90 x 2 1/2"	A	189	71	46	59	78	8	1174	16	11	7.4-17

Female Transition Coupler

4931



Type A

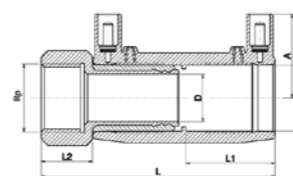

Type B

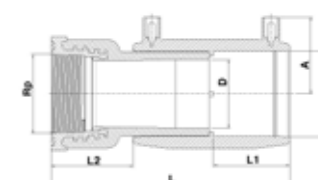

Product Code	Size d x Rp	Type	L	L1	L2	D	A	Carton	W	PN Water	SDR Gas	Pipe SDR Suitability
4931013	20 x 1/2"	A	96	37	20	14	35	200	130	16	11	7.4-11
4931014	25 x 3/4"	A	105	40	23	19	38	150	145	16	11	7.4-11
4931035	25 x 1"	A	108	34	28	23	42	80	252	16	11	7.4-11
4931015	32 x 3/4"	A	124	39	23	19	42	100	159	16	11	7.4-11
4931016	32 x 1"	B	130	44	40	27	43	100	265	16	11	7.4-11
4931036	32 x 1 1/4"	A	118	39	28	29	47	54	507	16	11	7.4-11
4931017	40 x 1"	A	122	47	25	29	46	54	507	16	11	7.4-11
4931018	40 x 1 1/4"	A	122	47	25	29	46	54	407	16	11	7.4-11
4931019	40 x 1 1/2"	A	122	47	25	29	46	48	419	16	11	7.4-11
4931020	50 x 1 1/2"	A	126	49	25	38	51	48	491	16	11	7.4-11
4931021	50 x 2"	A	131	49	30	38	51	40	685	16	11	7.4-11
4931022	63 x 1 1/2"	A	145	59	26	38	59	24	558	16	11	7.4-11
4931023	63 x 2"	B	179	57	62	49	58	30	840	16	11	7.4-17

Male Transition Coupler S/S 316

4951

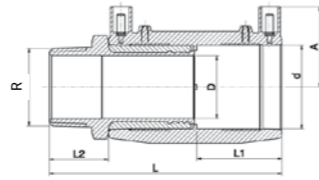

Product Code	Size d x R	A	D	L2	L	L1	Carton	W	PN Water	SDR Gas	Pipe SDR Suitability
4951015	32 x 1.1/4"	42	23	36	124	42	60	393	16	11	7.4-11
4951002	32 x 1.1/2"	41	23	36	126	44	64	450	16	11	7.4-11
4951003	40 x 1.1/4"	45	29	36	134	48	54	460	16	11	7.4-11
4951004	40 x 1.1/2"	45	29	36	134	48	54	460	16	11	7.4-11
4951005	50 x 1.1/2"	50	38	36	137	49	24	540	16	11	7.4-11
4951014	50 x 2"	59	38	41	160	49	30	752	16	11	7.4-11
4951006	63 x 1.1/2"	57	48	36	154	57	32	800	16	11	7.4-11
4951007	63 x 2"	57	48	41	159	57	30	890	16	11	7.4-17.6

Male Transition Union (Free Nut)

4941

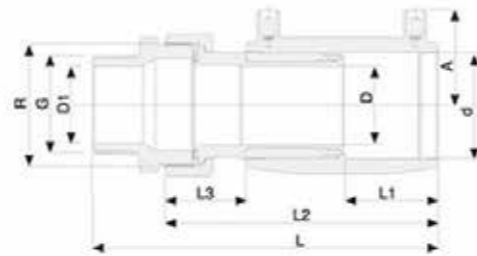

Product Code	Size d x R	A	d	D	L1	L2	Carton	W	PN Water	SDR Gas	Pipe SDR Suitability
4941001	32-1"	42	32	23	42	124	40	555	16	11	7.4 - 11
4941002	40-1"	45	40	29	47	136	30	779	16	11	7.4 - 11
4941003	40 - 1.1/4"	45	40	29	47	136	30	779	16	11	7.4 - 11
4941004	50 - 1.1/2"	50	50	38	49	142	-	-	16	11	7.4 - 11
4941005	63 - 1.1/2"	57	63	38	57	162	-	-	16	11	7.4 - 11
4941006	63 - 2"	57	63	48	57	167	-	-	16	11	7.4 - 17

PE Male Spigot Adaptor

4971

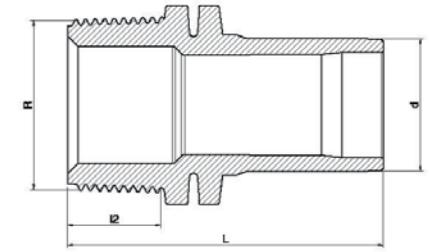

Product Code	Size d x R	L	L2	Carton	W	PN Water	SDR Gas
4971001	25 x 3/4"	65	19	600	20	16	11
4971002	32 x 1"	74	21	400	30	16	11
4971003	40 x 1"	80	21	200	55	16	11
4971004	40 x 1.1/4"	83	24	200	60	16	11
4971005	40 x 1.1/2"	82	24	200	65	16	11
4971006	50 x 1.1/2"	89	24	160	80	16	11
4971007	63 x 1.1/2"	102	25	128	150	16	11
4971008	63 x 2"	108	29	128	200	16	11

PE Female Spigot Adaptor

4961

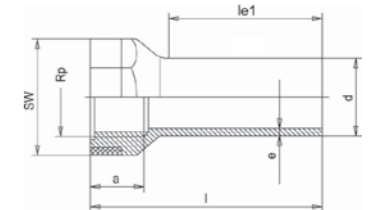

Product Code	Size d x Rp	le1	A	SW	I	Carton	W	PN Water	SDR Gas
4961001	20 x 1/2"	41	16	30	65	800	20	16	11
4961002	25 x 3/4"	41	18	36	63	600	22	16	11
4961003	32 x 1"	44	21	46	71	400	41	16	11
4961004	40 x 1.1/4"	49	23	55	79	240	62	16	11
4961005	50 x 1.1/2"	55	24	60	88	160	80	16	11
4961006	63 x 2"	63	29	75	97	80	143	16	11

With galvanised steel reinforcing ring.

Male Transition 90° Elbow

4925



Product Code	Size d x R	Type	L	L1	L2	D	A	Carton	W	PN Water	SDR Gas	Pipe SDR Suitability
4925001	20 x 1/2"	A	95	35	29	14	38	150	153	16	11	7.4-11
4925002	25 x 3/4"	A	95	37	29	19	38	120	168	16	11	7.4-11
4925003	32 x 1/2"	A	112	40	29	23	43	84	294	16	11	7.4-11
4925004	32 x 3/4"	A	112	40	29	23	43	84	262	16	11	7.4-11
4925005	32 x 1"	B	134	44	49	22	47	84	253	16	11	7.4-11
4925006	32 x 1 1/4"	A	119	40	36	23	43	60	419	16	11	7.4-11
4925007	32 x 1 1/2"	A	119	40	36	23	43	60	436	16	11	7.4-11
4925008	40 x 1"	B	142	44	49	22	47	48	458	16	11	7.4-17.6
4925009	40 x 1 1/4"	B	153	44	59	30	47	56	391	16	11	7.4-17.6
4925010	40 x 1 1/2"	A	128	44	36	29	47	48	510	16	11	7.4-17.6
4925011	40 x 2"	A	133	44	41	29	47	48	725	16	11	7.4-17.6
4925012	50 x 1"	A	142	48	34	38	52	42	624	16	11	7.4-17.6
4925013	50 x 1 1/4"	A	144	48	36	38	52	36	679	16	11	7.4-17.6
4925014	50 x 1 1/2"	B	174	49	63	35	52	36	655	16	11	7.4-17.6
4925015	50 x 2"	A	149	48	41	38	52	30	806	16	11	7.4-17.6
4925016	63 x 1 1/4"	A	167	57	36	48	59	24	985	16	11	7.4-17.6
4925017	63 x 1 1/2"	A	167	57	36	48	59	24	1040	16	11	7.4-17.6
4925018	63 x 2"	B	200	58	68	47	57	20	871	16	11	7.4-17.6

Male Transition 45° Elbow

4926

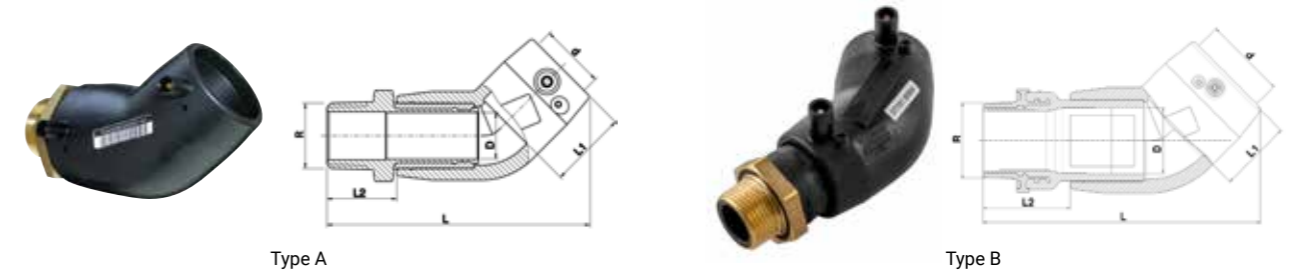

Product Code	Size d x R	Type	L	L1	L2	D	A	Carton	W	PN Water	SDR Gas	Pipe SDR Suitability
4926001	32 x 1/2"	A	124	39	29	23	43	84	249	16	11	7.4-11
4926002	32 x 3/4"	A	123	39	29	23	43	84	250	16	11	7.4-11
4926003	32 x 1"	B	151	44	50	22	42	80	242	16	11	7.4-11
4926004	32 x 1 1/4"	A	130	39	36	23	43	48	479	16	11	7.4-11
4926005	32 x 1 1/2"	A	130	39	36	23	43	48	488	16	11	7.4-11
4926006	40 x 1"	B	158	48	45	22	47	80	291	16	11	7.4-17.6
4926007	40 x 1 1/4"	B	168	48	55	30	47	64	364	16	11	7.4-17.6
4926008	40 x 1 1/2"	A	144	44	36	29	47	48	510	16	11	7.4-17.6
4926009	40 x 2"	A	149	44	41	29	47	40	685	16	11	7.4-17.6
4926010	50 x 1"	A	161	49	34	38	51	48	564	16	11	7.4-17.6
4926011	50 x 1 1/4"	A	161	49	36	38	51	48	610	16	11	7.4-17.6
4926012	50 x 1 1/2"	B	185	49	63	35	52	28	530	16	11	7.4-17.6
4926013	50 x 2"	A	165	49	41	38	51	30	778	16	11	7.4-17.6
4926014	63 x 1 1/4"	A	184	57	36	48	59	24	927	16	11	7.4-17.6
4926015	63 x 1 1/2"	A	184	57	36	48	59	24	893	16	11	7.4-17.6
4926016	63 x 2"	B	215	58	68	47	57	24	820	16	11	7.4-17.6

Female Transition 90° Elbow

4935

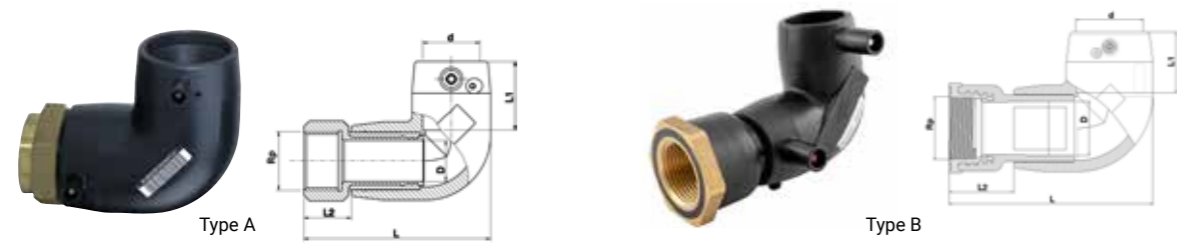

Product Code	Size d x Rp	Type	L	L1	L2	D	A	Carton	W	PN Water	SDR Gas	Pipe SDR Suitability
4935001	20 x 1/2"	A	86	35	20	14	38	160	142	16	11	7.4-11
4935002	25 x 3/4"	A	89	37	23	19	38	120	160	16	11	7.4-11
4935003	32 x 1"	B	123	39	42	27	42	96	280	16	11	7.4-11
4935004	40 x 1"	A	117	44	25	29	47	48	535	16	11	7.4-17.6
4935005	40 x 1 1/4"	A	117	44	25	29	47	48	432	16	11	7.4-17.6
4935006	40 x 1 1/2"	A	117	44	25	29	47	48	453	16	11	7.4-17.6
4935007	50 x 1 1/2"	A	133	48	25	38	52	48	560	16	11	7.4-17.6
4935008	50 x 2"	A	138	48	30	38	52	40	744	16	11	7.4-17.6
4935009	63 x 1 1/2"	A	161	57	30	48	59	24	1072	16	11	7.4-17.6
4935010	63 x 2"	B	193	58	62	49	57	24	959	16	11	7.4-17.6

Female Transition 45° Elbow

4936

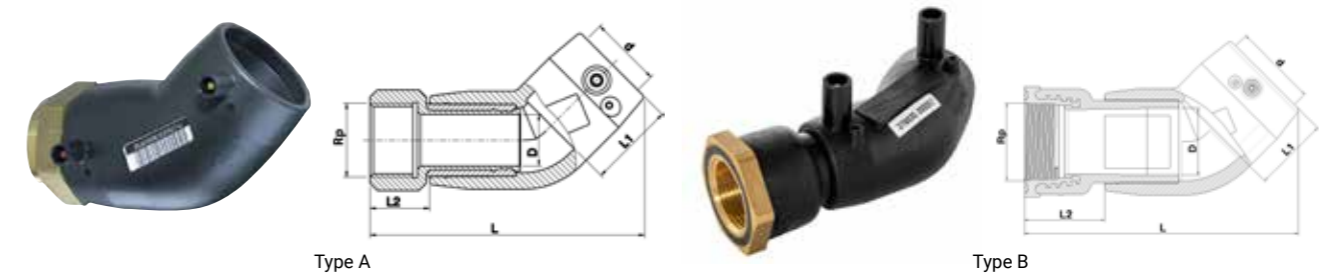

Product Code	Size d x Rp	Type	L	L1	L2	D	A	Carton	W	PN Water	SDR Gas	Pipe SDR Suitability
4936001	32 x 1"	B	141	44	40	27	42	72	342	16	11	7.4-11
4936002	40 x 1"	A	133	44	25	29	47	48	510	16	11	7.4-17.6
4936003	40 x 1 1/4"	A	133	44	25	29	47	48	419	16	11	7.4-17.6
4936004	40 x 1 1/2"	A	133	44	25	29	47	48	479	16	11	7.4-17.6
4936005	50 x 1 1/2"	A	150	49	25	38	51	48	532	16	11	7.4-17.6
4936006	50 x 2"	A	155	49	30	38	51	36	702	16	11	7.4-17.6
4936007	63 x 1 1/2"	A	178	57	30	48	59	24	1019	16	11	7.4-17.6
4936008	63 x 2"	B	208	58	62	49	57	24	912	16	11	7.4-17.6

Female Free Nut Transition Coupler

4941

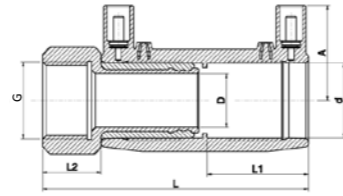

Product Code	Size d x G	L	L1	L2	D	A	Carton	W	PN Water	SDR Gas	Pipe SDR Suitability
4941007	20 x 3/4"	106	37	30	14	34	200	160	16	11	7.4-11
4941008	25 x 3/4"	112	40	30	14	37	140	150	16	11	7.4-11
4941009	25 x 1"	115	40	33	19	37	140	200	16	11	7.4-11
4941033	32 x 3/4"	100	39	20	14	42	100	164	16	11	7.4-11
4941010	32 x 1"	124	42	36	19	42	100	260	16	11	7.4-11
4941011	32 x 1 1/4"	124	42	36	23	42	78	310	16	11	7.4-11
4941012	40 x 1 1/4"	113	44	23	23	47	52	320	16	11	7.4-11
4941013	40 x 1 1/2"	135	47	38	29	45	52	444	16	11	7.4-11
4941014	50 x 1"	136	49	36	19	52	32	700	16	11	7.4-11
4941015	50 x 2"	141	49	41	38	52	32	709	16	11	7.4-11
4941016	63 x 2"	161	57	44	38	57	28	770	16	11	7.4-17.6
4941017	63 x 2 1/2"	166	57	49	48	57	20	1154	16	11	7.4-17.6
4941035	75 x 2 1/2"	175	66	49	48	66	-	-	16	11	7.4-17.6
4941034	90 x 2 1/2"	192	71	49	48	78	-	-	16	11	7.4-17.6

Female Free Nut Transition 90° Elbow

4945

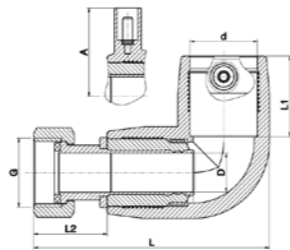

Product Code	Size d x G	L	L1	L2	D	A	Carton	W	PN Water	SDR Gas	Pipe SDR Suitability
4945001	20 x 3/4"	96	35	30	14	38	140	164	16	11	7.4-11
4945002	25 x 3/4"	96	37	30	14	38	140	164	16	11	7.4-11
4945003	25 x 1"	99	37	33	19	38	105	164	16	11	7.4-11
4945004	32 x 1"	119	40	36	19	43	70	164	16	11	7.4-11
4945005	32 x 1 1/4"	119	40	36	23	43	70	324	16	11	7.4-11
4945006	40 x 1 1/2"	132	44	40	29	47	48	490	16	11	7.4-17.6
4945007	50 x 2"	149	48	41	38	52	30	779	16	11	7.4-17.6
4945009	63 x 2"	175	57	44	41	59	16	1024	16	11	7.4-17.6
4945010	63 x 2 1/2"	180	57	49	48	59	16	1245	16	11	7.4-17.6

Female Free Nut Transition 45° Elbow

4946

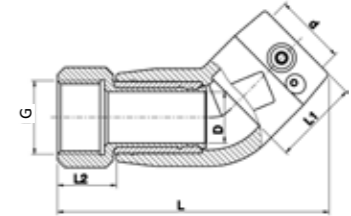

Product Code	Size d x G	L	L1	L2	D	A	Carton	W	PN Water	SDR Gas	Pipe SDR Suitability
4946001	32 x 1"	131	39	36	19	43	70	164	16	11	7.4-11
4946002	32 x 1 1/4"	129	39	34	23	47	56	400	16	11	7.4-11
4946003	40 x 1 1/2"	146	44	38	29	47	48	469	16	11	7.4-17.6
4946004	50 x 2"	166	49	41	38	51	30	740	16	11	7.4-17.6
4946005	63 x 2"	189	57	41	38	59	24	164	16	11	7.4-17.6
4946006	63 x 2 1/2"	197	57	44	48	59	16	1184	16	11	7.4-17.6

PE Male Transition Coupler

4971

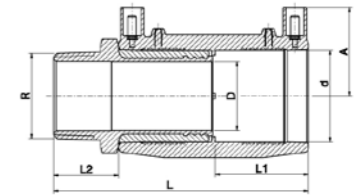

Product Code	Size d x R	L	L1	D	A	Carton	W	PN Water	SDR Gas	Pipe SDR Suitability
4971009	25 x 3/4"	113	31	18	37	200	61	16	11	7.4-11
4971010	32 x 1"	123	35	24	42	200	92	16	11	7.4-11
4971011	40 x 1"	134	37	30	46	128	146	16	11	7.4-11
4971012	40 x 1 1/4"	137	40	30	46	128	152	16	11	7.4-11
4971013	40 x 1 1/2"	137	40	30	46	128	159	16	11	7.4-11
4971014	50 x 1 1/2"	141	40	38	51	96	238	16	11	7.4-11
4971015	63 x 1 1/2"	161	44	48	57	40	371	16	11	7.4-17.6
4971016	63 x 2"	165	48	48	57	40	450	16	11	7.4-17.6

PE Cast Iron Flange Transition Coupler

4977

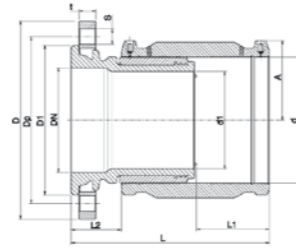

Product Code	Size d x DN	A	L	L1	L2	D1	d1	D	Dp	s	t	No. of holes	Carton	W	PN Water	SDR	Pipe SDR Suitability
4977001	63 x 50	57	217	57	100	104	43	165	125	18	20	4	4	4200	16	11	7.4-17.6
4977002	110 x 100	79	223	80	61	159	84	220	180	18	22	8	4	7280	16	11	7.4-17.6
4977003	125 x 100	87	235	85	62	159	98	220	180	18	22	8	4	7759	16	11	7.4-17.6
4977004	160 x 150	105	268	93	73	215	125	285	240	22	24	8	1	13400	16	11	7.4-21
4977005	180 x 150	116	284	105	72	215	140	285	240	22	24	8	1	15246	16	11	7.4-17.6
4977006	225 x 200	138	314	119	74	270	176	340	295	22	26	8	1	23919	16	11	7.4-17.6

PE-Steel Weldable Transitions

4977

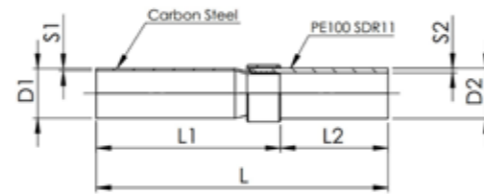

Product Code	Size D2 x DN	Steel	D1	L*	L1*	L2*	S1	Carton	W	SDR Gas
4927001	32-1" (DN25)	SCH80	33.7	475	145	330	4.55	1	1300	11
4927002	40-1.1/4" (DN32)	SCH80	42.4	475	145	330	4.85	1	1700	11
4927003	50-1.1/2" (DN40)	SCH80	48.3	475	145	330	5.08	1	2100	11
4927004	63-2" (DN50)	SCH80	60.3	475	145	330	5.54	1	3200	11
4927005	63-2" (DN50)	SCH40	60.3	475	145	330	3.91	1	2500	11
4927029	90-3" (DN80)	SCH40	88.9	489	159	330	5.49	1	4900	11
4927006	110-4" (DN100)	SCH40	114.3	489	159	330	6.02	1	7400	11
4927007	125-4" (DN100)	SCH40	114.3	489	159	330	6.02	1	7800	11
4927008	160-6" (DN150)	SCH40	168.3	614	214	400	7.11	1	17000	11
4927009	200-8" (DN200)	SCH40	219.1	614	214	400	8.18	1	28400	11
4927010	250-10" (DN250)	SCH40	273.0	765	270	495	9.27	1	46900	11
4927011	315-12" (DN300)	SCH40	323.9	765	270	495	10.31	1	70000	11
4927012	355-12" (DN300)	SCH40	323.9	795	300	495	10.31	1	74300	11
4927013	400-16" (DN400)	SCH40	406.4	895	300	595	12.7	1	132800	11
4927014	560-20" (DN500)	SCH40	558.8	895	300	595	15.88	1	204000	11
4927015	630-24" (DN600)	SCH40	609.6	895	300	595	17.48	1	302800	11

*Minimum length.
Custom fittings available (dimensions, various PE SDR's and steel schedules)

PE-Steel Weldable Transitions

4977

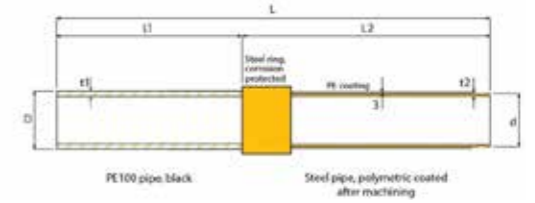

Product Code	Size D x DN	d	L	L1	L2	t1	t2	Carton	W	PN Water	SDR
4927022	125 x 4"	114.3 (DN100)	935	400	535	11.3	6.02	1	4200	16	11
4927023	180 x 6"	165.1 (DN150)	800	400	400	16.4	5.5	1	7280	16	11

Wastewater Adjustable Saddle

4758

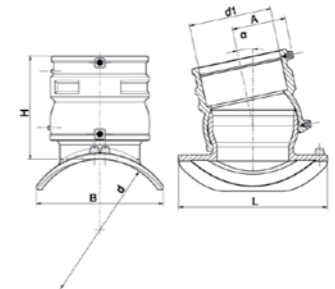

Product Code	Size d x d1	B	H	A	L	Carton	W	PN Water	Pipe SDR Suitability
4758006	200 x 160	208	202	105	290	4	2050	0.5	17-26
4758003	225-250 x 160	225	202	105	290	4	2060	0.5	17-26
4758004	280-315 x 160	247	202	105	290	4	2070	0.5	17-26
4758005	355-560 x 160	263	202	105	290	4	2080	0.5	17-26
4758007	560-710 x 160	277	202	105	290	4	2100	0.5	17-26

Requires specialised installation tool.

Wastewater 45° Saddle - Inlet 110

4758

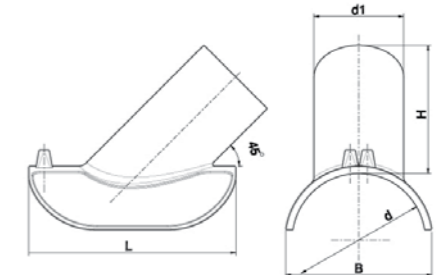

Product Code	Size d x d1	L	B	H	Carton	W	PN Water	Pipe SDR Suitability
4758001	160-200 x 110	255	182	158	10	710	0.5	11-26
4758002	225-315 x 110	255	221	158	10	656	0.5	11-26

See Tooling section for dedicated installation tools.

Wastewater Saddle Spigot Inlet

4758

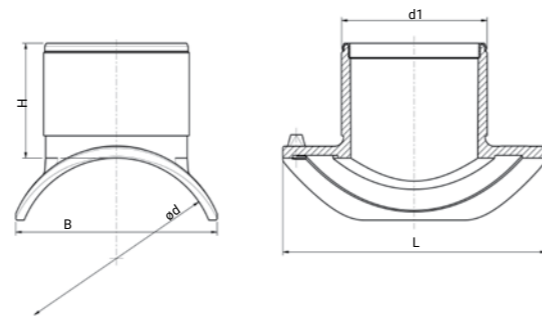

Product Code	Size d x d1	B	H	L	Carton	W	PN Water	Pipe SDR Suitability
4758008	200 x 160	208	125	290	6	1091	0.5	17-26
4758009	225 - 250 x 160	225	125	290	6	1239	0.5	17-26
4758010	280 - 315 x 160	247	125	290	6	1260	0.5	17-26
4758011	355 - 560 x 160	263	125	290	6	1300	0.5	17-26
4758012	560 - 710 x 160	277	125	290	6	1310	0.5	17-26

Wastewater Manhole Adaptor

3702/4772

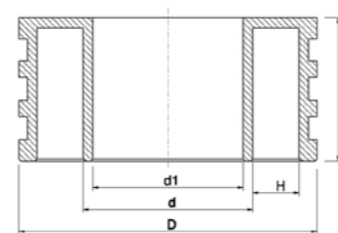

Product Code	Size d	L	d1	D	H	Carton	W	PN Water
4772001	160	135	141	280	39	6	2524	0.5
3702001	180	135	157	335	66	4	3550	0.5
3702002	200	135	176	355	56	2	3660	0.5
4772002	225	135	198	355	44	2	3902	0.5
3702003	250	135	220	400	54	2	3740	0.5
4772003	280	135	247	400	39	2	5027	0.5
3702004	315	135	278	450	46	2	5130	0.5
3702005	355	135	313	500	50	2	6480	0.5
3702006	400	135	353	560	59	1	8260	0.5
3702007	500	135	441	651	54	1	23600	0.5
3702008	560	135	494	705	51	1	34500	0.5
3702009	630	135	555	773	50	1	47370	0.5

SMARTFUSE APP

LIKE AN EXTRA PAIR OF HANDS ON THE JOB



Control your SmartFuse welding control box from your Smartphone with no mobile coverage needed!

Improved quality control

Fully guided weld process

Photo capture of key steps (stored with weld record)

Weld data recording including GPS location

Record and store installers for each weld

Ability to weld all fittings*



*Monomatic Control Boxes will be limited to emergency welds of other fittings

smartfuseapp.plasson.com.au

 PLASSON

TOOLING

 **PLASSON**[®]
Made in Germany ... another PLASSON quality product manufactured by **PFS**

2001

Page 157 | Electrofusion Control Boxes



2003

Page 157 | Welding Terminal Pin Adaptors



2900

Page 157 | Parts for Universal Terminals



2002

Page 158 | Control Box Accessories and Parts



2002/2003

Page 159 | Ruling and Marking



2004

Page 159 | Pipe Cutters



2005

Page 160 | Pipe Wipes



2006

Page 160 | Drill Powered Pipe End Peeler



2006

Page 161 | Pipe Peelers



2006

Page 161 | Rotational Pipe Peeler Tool



2006

Page 162 | Rotational Pipe End Peeler



2004

Page 162 | Uni-Peeler



2006

Page 163 | Rotational Chain Peelers



2006

Page 163 | Battery Powered Chain Peelers



2012

Page 163 | Electrical Saddle Peelers (Greater than 110mm)



2006

Page 164 | Pipe Beveller



2007

Page 164 | Alignment Clamps



2007

Page 164 | Pipe Clamps



2008

Page 165 | Rounding Clamp



2008

Page 165 | Hydraulic Rounding Tools



2008

Page 166 | Rounding Tools



2009

Page 166 | Squeeze Off Tools



2007

Page 167 | Pipe Support



2011

Page 167 | Specialised Installation Tooling for Plasson Products



2012

Page 168 | Large Bore Saddle Clamps



2012

Page 168 | Large Bore Saddle Clamp Parts



2012

Page 169 | Drill and Motors



2012

Page 169 | Core Cutters



2003

Page 170 | Radius Gauge



Control Boxes

Control Box Comparison Table

Features	SmartFuse 180	SmartFuse 355	Polymatic Plus USB	PolyControl Plus V2
Fitting size	Up to 180mm (Sizes above 125mm require cool down time between welds)	Up to 355mm	Up to 800mm (Sizes above 355mm require cool down time between welds)	All Sizes
Welds	Plasson Only (Able to weld other brands via SmartFuse App)	Plasson Only (Able to weld other brands via SmartFuse App)	Any Brands	Any Brands
Weld Tip Size	4.7/4.0mm Universal	4.7/4.0mm Universal	4.7/4.0mm Universal	4.7/4.0mm Universal
Bluetooth	Y	Y	Y	Y
Plasson SmartFuse Mode (Automatic)	Y	Y	Y	Y
Manual Input of Welding Time	N	N	Y	Y
Welding Voltage	40V	40V	8-48V	8-48V
Output Current	54A Max (14 Nominal)	110A Max (30 Nominal)	110A Max (40 Nominal)	110A Max (85 Nominal)
Data Recording	Y with App	Y with App	Y	Y
Multilingual Display Messages	Y	Y	Y	Y
Error Messages In Plain Text	Y	Y	Y	Y
Adjustable Display Contrast	Y	Y	Y	Y
Dynamic Process Supervision	Y	Y	Y	Y
Auto Software Check	Y	Y	Y	Y
Resistance Check	Y	Y	Y	Y
Ramped Start	Y	Y	Y	Y
Service Message	After 200 Hours or 12 Months	After 200 Hours or 12 Months	After 200 Hours or 12 Months	After 200 Hours or 12 Months
Barcode Reading Capability	Y with App	Y with App	Y	Y
Fitting And Operator Traceability	Y with App	Y with App	Y	Y
Earth Pin	10A	15A	15A	15A
Active Cooling	N	N	N	Y

MINIMUM REQUIRED GENERATOR OUTPUT POWER

240 V, 50Hz, 1-PHASE.

FITTING DIAMETER	OUTPUT POWER
20-160mm	3.2 kW
180-500mm	4.5 kW (Mechanically Controlled) 5 kW (Electronically Controlled)
> 500mm	6.5 kW (Mechanically Controlled) 7.5 kW (Electronically Controlled)

EXTENSION CORD

EXTENSION CORD	CONDUCTOR CROSS-SECTION
Up to 20m	3m x 1.5mm ²
20m - 50m	3m x 2.5mm ²

Detailed Specifications for each model available from Plasson.



DOWNLOAD THE PLASSON SERVICE REQUEST FORM

<https://plasson.com.au/service-request-form/>



Electrofusion Control Boxes

2001



SmartFuse 180



SmartFuse 355



Polymatic Plus USB



PolyControl Plus V2

Product Code	Description	Lead Size
2001026	SmartFuse 180	3m Fixed lead
2001001	SmartFuse 355	5m Lead
2001002	SmartFuse 355	10M Lead
2001003	SmartFuse 355	15M Lead
2001005	Polymatic Plus USB	5M Lead
2001006	Polymatic Plus USB	10M Lead
2001007	Polymatic Plus USB	15M Lead
2001008	PolyControl Plus V2	10M Fixed Lead

Welding Terminal Pin Adaptor

2003



Angled Adaptor



SmartFuse Angled Adaptor

Product Code	Description	Size
2003001	Angled Adaptor	4.0/4.7
2003002	Angled Adaptor	4.7/4.0
2003003	SmartFuse Angled Adaptor	4.7/4.7
2003004	SmartFuse Angled Adaptor	4.7/4.0
2003010	SmartFuse Angled Adaptor	4.0/4.7

Parts for Universal Terminals

2900



Product Code	Description
2900283	Welding Terminal Sleeve
2900284	Spring
2900285	Welding Terminal - Standard
2900289	Welding Terminal - SmartFuse
2900347	Terminal Kit

RURAL COMPRESSION
THREADED FITTINGS
METRIC COMPRESSION
TAPPING SADDLES
VALVES
ELECTROFUSION
TOOLING
SIMONA SPIGOTS
ASSEMBLY INSTRUCTIONS

Control Box Accessories and Parts

2002



2002015



2900394

Product Code	Description
Barcode Scanners	
2002015	Barcode Scanner DL (Powerscan incl. Cable & Hooded Bag)
2900394	Barcode Scanner Touch ID for New Gen (RX Machines)



2002017



2002043



2002037

Transport Cases	
2002017	Orange Transport Case (Monomatic / Digimatic / Polymatic Plus)
2002016	Flight Case (Monomatic / Digimatic / Polymatic Plus)
2002043	Orange Transport Case For Type 2 Polymatic/Smartfuse 355
2002037	Flight Case For Polycontrol Plus V2



2002016

Welding Cables and Accessories		
2002001	SmartFuse 355	5m Detachable Lead
2002002	SmartFuse 355	10m Detachable Lead
2002003	SmartFuse 355	15m Detachable Lead
2002004	Polymatic Plus USB	5m Detachable Lead
2002005	Polymatic Plus USB	10m Detachable Lead
2002006	Polymatic Plus USB	15m Detachable Lead
2002007	15Amp Extension Cable	15m Power Cable
2002008	15Amp Extension Cable	30m Power Cable

Ruling and Marking

2002/2003



2003006



2003007



2002032

Product Code	Description
2003006	Magnetic Circular Pipe Ruler
2003007	Pi-Meter 20-700mm with Vernier 0.1mm
2003008	Pi-Meter 1200mm with Vernier 0.1mm
2003011	Pipe Tape 630
2002032	Marking pens broad white (12pens / 1box)
2002033	Marking pens fine white (12pens / 1box)

Pipe Cutters

2004



2004001



2004004



2004016

Product Code	Description	Size
2004001	Pipe Cutter (Single Hand) Secateur	Up to 63mm
2004002	Pipe Cutter Spare Blade for 63mm (Single Hand)	Up to 63mm
2004004	Rotational Pipe Cutter	20-75mm
2004005	Rotational Pipe Cutter Spare Blade	20-75mm
2004006	Rotational Pipe Cutter	50-140mm
2004007	Rotational Pipe Cutter	90-160mm
2004008	Rotational Pipe Cutter Spare Blade	50-140 / 90 -160mm
2004018	Rotary Circular Saw Kit (Max. Cutting Depth 38mm)	180-400mm
2004015	Rotary Circular Saw Kit (Max. Cutting Depth 65mm)	250-500mm
2004016	Rotary Circular Saw Kit (Max. Cutting Depth 85mm)	500-1200mm
2004017	Extension links for the 500-1200mm Rotary Circular Saw Kit.	1200-1600mm

Pipe Wipes

2005



2005017

Product Code	Description
2005017	Plasson Pipewipes

Specialised moist wipes impregnated with a high specification solution containing 70% Isopropyl Alcohol. Plasson Pipewipes ensure surfaces are clean before electrofusion jointing (peeling of pipe surface is still required). 120 sheets per canister.

Drill Powered Pipe End Peeler

2006



2006035



2006057

Product Code	Description	Size
2006035	Pipe End Peeler Powered Drill C/W Mandrels SDR11	20-75mm
2006057	Mandrels for Pipe End Peeler	20mm SDR11 Series 2 (Gas)
2006073	Mandrels for Pipe End Peeler	25mm SDR11 Series 2 (Gas)
2006063	Mandrels for Pipe End Peeler	20mm SDR17 Series 2 (Gas)
2006064	Mandrels for Pipe End Peeler	25mm SDR17 Series 2 (Gas)
2006038	Mandrels for Pipe End Peeler	20mm SDR11
2006058	Mandrels for Pipe End Peeler	32mm SDR11
2006059	Mandrels for Pipe End Peeler	40mm SDR11
2006060	Mandrels for Pipe End Peeler	50mm SDR11
2006061	Mandrels for Pipe End Peeler	63mm SDR11
2006062	Mandrels for Pipe End Peeler	75mm SDR11
2006065	Mandrels for Pipe End Peeler	25mm SDR17
2006067	Mandrels for Pipe End Peeler	32mm SDR17
2006068	Mandrels for Pipe End Peeler	40mm SDR17
2006069	Mandrels for Pipe End Peeler	50mm SDR17
2006070	Mandrels for Pipe End Peeler	63mm SDR17
2006071	Mandrels for Pipe End Peeler	75mm SDR17

Pipe Peelers

2006



2006001

Product Code	Description	Size
2006001	Hand Peeler	Small 1.1/2"
2006002	Blades for Small Hand Peeler	Small 1.1/2"
2006003	Hand Peeler	Large 2.1/2"
2006004	Blades for Large Hand Peeler	Large 2.1/2"

Rotational Pipe Peeler Tool

2006



2006015

Product Code	Size
2006013	20-63mm
2006014	20-125mm
2006015	90-315mm
2006012	Spare Blade for Rotational Peelers 20-63 / 20-125mm
2006016	Spare Blade for Rotational Peelers 90-315mm

Rotational Pipe End Peeler

2006



2006017



2006086

Product Code	Description	Size
2006017	Rotational Pipe End Peeler	63 – 200mm
2006018	Rotational Pipe End Peeler	90 – 315mm
2006019	Rotational Pipe End Peeler	180 – 400mm
2006086	Rotational Pipe End Peeler	450 – 1000mm
2006020	Spare Blade for Rotational Pipe End Peeler	63 – 200mm
2006029	Spare Blade for Rotational Pipe End Peeler	90–315 / 180–400mm
2006016	Spare Blade for Rotational Pipe End Peeler	450 - 1000mm
2006074	Rotational Pipe End Peeler with 3 way rails	90 - 315
2006075	Rotational Pipe End Peeler with 3 way rails	180 - 400

Uni-Peeler

2006



2006051

Product Code	Size
2006051	63mm
2006052	73mm
2006039	90mm
2006040	110mm
2006041	125mm
2006042	140mm
2006043	160mm
2006044	180mm
2006045	200mm
2006046	225mm
2006079	250mm
2006080	280mm
2006081	315mm
2006012	Spare Blade for Uni-Peelers 63–180mm
2006016	Spare Blade for Uni-Peelers 200–315mm

Rotational Chain Peelers

2006



2006049

Product Code	Description	Size
2006049	Rotational Chain Peeler	110-400mm
2006021	Rotational Chain Peeler	250-450mm
2006022	Rotational Chain Peeler	250-800mm
2006024	Rotational Chain Peeler	800-1200mm
2006027	Extension Links Chain Peeler	500-800mm (For 250-450mm)
2006023	Extension Links Chain Peeler	900-1000mm (For 250-800mm)

Battery Powered Chain Peelers

2006



Product Code	Description	Size
2006047	Self Driven Battery Powered Chain Peeler (Cordless) Incl. 2 Batteries and 1 Charger	400-800mm
2006048	Self Driven Battery Powered Chain Peeler (Cordless) Incl. 2 Batteries and 1 Charger	800-1200mm
2006050	Extension Links for Powered Chain Peelers	900-1000mm (For 400-800mm)
2006055	Extension Links for Powered Chain Peelers	1400-1600mm (For 800-1200mm)

Saddle Peelers (Greater than 110mm)

2012



2012003



2012084

Product Code	Description
2012003	Electrical Saddle Peeler 230V
2012004	Pneumatic Saddle Peeler
2012006	Electrical Saddle Peeler (Cordless)
2012084	Manual Saddle Peeler

Pipe Beveller

2006



2006090

Product Code	Description	Size
2006090	Pipe Beveller	20-250
2006026	Pipe Beveller	40-315
2006025	Spare Blade for Pipe Bevelers	--

Alignment Clamps

2007



2007011

Product Code	Size
2007001	16-63mm
2007002	32-110mm
2007011	63-225mm

Pipe Clamps

2007



2007005



2007006

Product Code	Description	Size
2007005	4 pipe clamps, 2 base bars, angled adaptor 22.5°, 45°, 90° & 180°	110-560mm
2007006	Large Diameter Pipe Clamps (With 2 fixed clamps, 2 clamps required)	250-800mm
2007007	Large Diameter Pipe Clamps Set (2 complete clamps each with a pulling clamp, a fixed clamp and pulling shoes for couplers. Allows you to pull the coupler over the pipe and the opposite pipe into the coupler to complete the insertion.)	250-800mm
2007010	Large Diameter Pipe Clamps Set (2 complete clamps each with a pulling clamp, a fixed clamp and pulling shoes for couplers. Allows you to pull the coupler over the pipe and the opposite pipe into the coupler to complete the insertion.)	630-1200mm

Rounding Clamp

2008



2008001



2008003



2008013

Product Code	Description	Size
2008001	Rounding Clamp (inc adaptor)	40mm (32)
2008002	Rounding Clamp (inc adaptor)	63mm (50)
2008003	Rounding Clamps (Deforming force 0.85 tonne) Sold as a pair	63-180mm
2008004	Rounding Clamps (Deforming force 1.2 tonne) Sold as a pair	110-250mm
2008005	Rounding Clamps (Deforming force 2.2 tonne) Sold as a pair	180-315mm
2008006	Rounding Clamps (Deforming force 3.5 tonne) Sold as a pair	250-400mm
2008007	Rounding Ring	63mm
2008008	Rounding Ring	75mm
2008009	Rounding Ring	90mm
2008010	Rounding Ring	110mm
2008011	Rounding Ring	125mm
2008012	Rounding Ring	140mm
2008013	Rounding Ring	160mm
2008014	Rounding Ring	180mm
2008015	Rounding Ring	200mm
2008016	Rounding Ring	225mm
2008017	Rounding Ring	250mm
2008018	Rounding Ring	280mm

Hydraulic Rounding Tools

2008



Hydraulic Jack with Rounding Shell

Product Code	Description	Size
2008019	Hydraulic Jack	315-400mm
2008020	Hydraulic Rounding Shell	315mm
2008021	Hydraulic Rounding Shell	355mm
2008022	Hydraulic Rounding Shell	400mm
2008023	Hydraulic Jack	450-630mm
2008024	Hydraulic Rounding Shell	450mm
2008025	Hydraulic Rounding Shell	500mm
2008026	Hydraulic Rounding Shell	560mm
2008027	Hydraulic Rounding Shell	630mm
2008028	Hydraulic Jack	710-900mm
2008029	Hydraulic Rounding Shell	710mm
2008030	Hydraulic Rounding Shell	800mm
2008031	Hydraulic Rounding Shell	900mm

Rounding Tools

2008



2008033



2008048

Product Code	Description	Size
2008033	Mechanical Rounding Tool	450 – 1000mm
2008048	Hydraulic Strap Rounding Tool	450 – 710mm
2008049	Hydraulic Strap Rounding Tool - Extension	800 – 1200mm (For 450-710mm)
2008050	Hydraulic Strap Rounding Tool	450 – 1200mm

Squeeze Off Tools

2009



2009002



2009003

Product Code	Size
2009002	16 - 63mm SDR 11 Sizes: 16/20, 25, 32, 40, 50, 63mm SDR17 Size: 63mm
2009009	63 - 90mm SDR 11 & 17 Sizes: 63, 75, 90mm
2009003	Hydraulic 63 - 200mm (Excl. 140mm) Suits SDR 11 & 17 (incl. 2 complete stopper sets) Sizes: 63, 75, 90, 110, 125, 160, 180, 200mm

Pipe Support

2007



2007008



2007012

Product Code	Description	Size
2007008	Pipe Support	to 225mm
2007012	Pipe Support	200-1400mm

Specialised Installation Tooling for Plasson Products

2011



2011001



2011002



2012005



2015002

Product Code	Description	Size
2011001	Waste Water Clamping & Cutting Tool Set 110 Mains pipe sizes DN160-DN315. Includes: Saddle clamp unit. Cutter. Drill not included	110mm X 45° fixed outlet saddle clamp kit
2011002	Tool for Waste Water Saddle 160 Main pipe sizes DN225-DN560 Includes: Saddle clamp unit. Core drill kit	160mm Flexible Outlet Saddle Clamp Kit
2012005	Flex Restraint installation clamp	160-900mm
2012062	Flex Restraint installation clamp	160-1600mm
2015002	Sensor Saddle Kit with Plastic Adaptor Plates	110-1200mm

Large Bore Saddle Clamps

2012



2012001



2012020



2012040

Product Code	Description	Size
2012001	Large Bore Saddle Clamp Kit 250-900mm - Splitable & Incl. Straps	90 - 110 - 125 - 160
2012020	Tension Strap Kit For Saddle Clamping Plates <180mm Incl. Straps/Ratchets/Suitcase Saddle Clamp	250 - 1200MM
2012040	Splitable Clamping Plate Incl. Suitcase & Rounding Ring	180 & 200 Offtake
2012018	Splitable Clamping Plate Incl. Suitcase & Rounding Ring	225 & 250 Offtake
2012029	Splitable Clamping Plate Incl. Suitcase & Rounding Ring	280 & 315 Offtake
2012019	Splitable Clamping Plate Incl. Suitcase & Outlet Rounder	355 & 400 Offtake

Large Bore Saddle Clamp Parts

2012



2012010



2012038

Product Code	Description
2012035	Pressing Tool For Plasson Repair Saddle 250 - 900mm (Bar Only)
2012073	Pressing Tool for Plasson Saddle Outlet 400MM/PN16 FLANGE (Bar Only)
2012010	Pressure Test Pipe Removal Tool For Plasson Saddle (Ptprt)
2012038	Adapter For Pressure Test Pump 1/2" For Plasson-Saddle

Drill and Motors

2012



2012016



2012054

Product Code	Description
2012016	Drill Be75-X3 Quick For Plasson Core Cutters
2012031	XXL Driller - Saddle Motor DN250-DN400 230v
2012054	Clamping Ring 160mm/SDR11 For XXL Driller
2012032	Clamping Ring 250mm/SDR11 For XXL Driller
2012033	Clamping Ring 315mm/SDR11 For XXL Driller
2012034	Clamping Ring 400mm/SDR11 For XXL Driller

Core Cutters

2012



2012002



2012002

Product Code	Description
2012002	Large Bore Core Drill Kit - Includes Core Cutters For Saddle Outlet 90-110-125 And 160mm
2012053	Core Cutter For Plasson Saddle 2" Outlet; Borehole 45mm Incl. Adaptor Drill And Case
2012046	Core Cutter For Plasson Saddle 90mm/Sdr11; Borehole 71mm Incl. Adaptor Drill And Case
2012047	Core Cutter For Plasson Saddle 110mm/Sdr11; Borehole 87mm Incl. Adaptor Drill And Case
2012057	Core Cutter For Plasson Saddle 125mm/Sdr11, Borehole 98mm Incl. Adaptor Drill And Case
2012055	Core Cutter For Plasson Saddle 125mm/Sdr17, Borehole 108mm Incl. Adaptor Drill And Case
2012059	Core Cutter For Plasson Saddle 160mm/Sdr11, Borehole 127mm Incl. Adaptor Drill And Case
2012050	Core Cutter For Plasson Saddle 180mm/Sdr11; Borehole 143mm Incl. Adaptor Drill And Case
2012037	Core Cutter For Plasson Saddle 200mm/Sdr11; Borehole 159mm Incl. Adaptor Drill And Case
2012044	Core Cutter For Plasson Saddle 225mm/Sdr11; Borehole 179mm Incl. Adaptor Drill And Case
2012026	Core Cutter For Plasson-Saddle 225mm/Sdr17, Borehole 196mm Incl. Adaptor Drill And Case
2012015	Core Cutter For Plasson Saddle 250mm/Sdr11; Borehole 199mm Incl. Adaptor Drill And Case
2012051	Core Cutter For Plasson Saddle 280mm/Sdr11; Borehole 233mm Incl. Adaptor Drill And Case
2012028	Core Cutter For Plasson Saddle 315mm/Sdr11; Borehole 251mm Incl. Adaptor Drill And Case
2012052	Core Cutter For Plasson Saddle 355mm/Sdr11; Borehole 283mm Incl. Adaptor Drill And Case
2012022	Core Cutter For Plasson Saddle 400mm/Sdr11; Borehole 319mm Incl. Adaptor Drill And Case

Radius Gauge

2003



2003012

Product Code	Size
2003012	250
2003013	280
2003014	315
2003015	355
2003016	400
2003017	450
2003018	500
2003019	560
2003020	630
2003021	710
2003022	800
2003023	900
2003024	1000
2003025	1200

Used to measure ovality and identify flat spots along a pipeline.

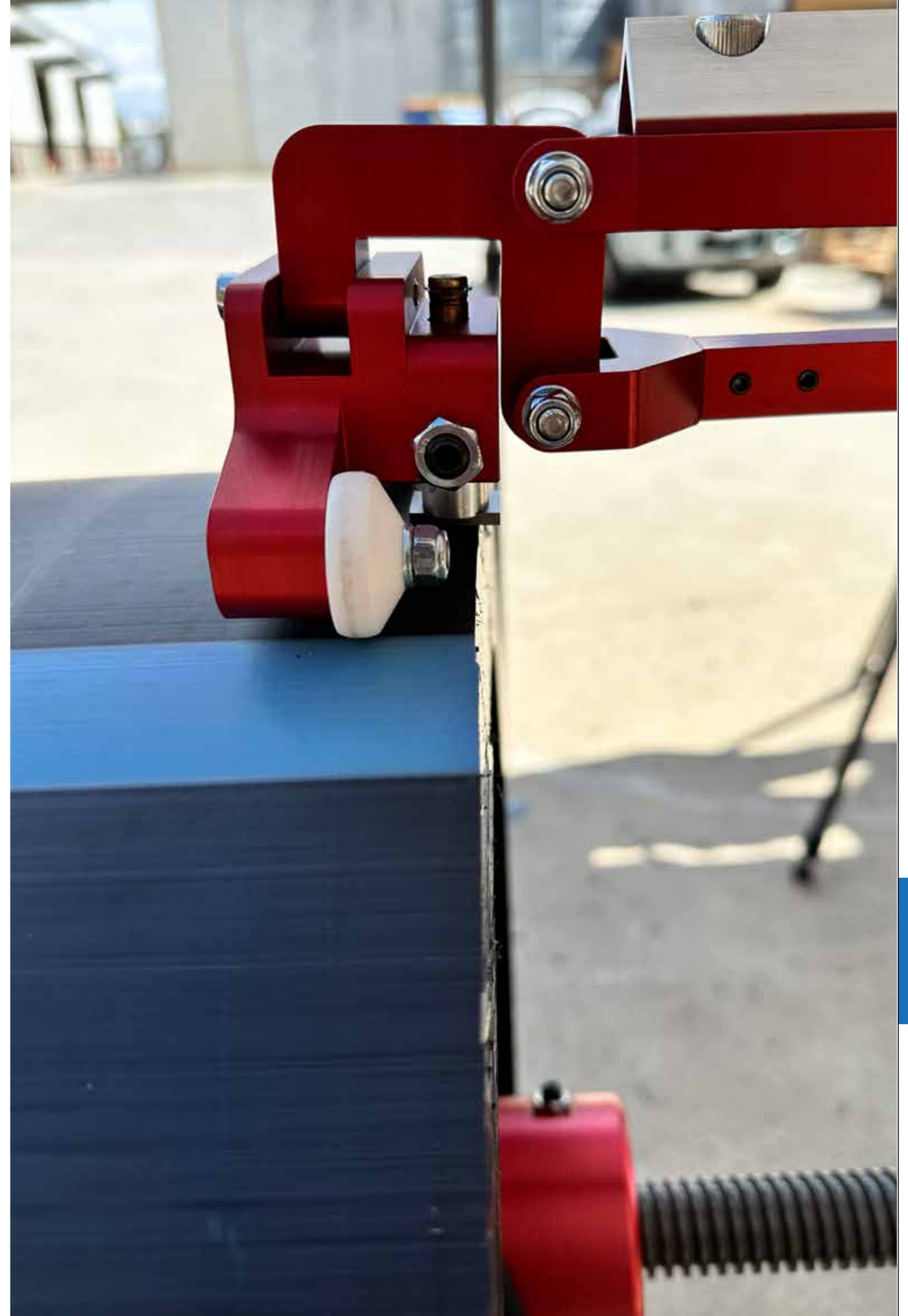

 PLASSON

SIMONA SPIGOTS

SIMONA

Ø 450 mm

SIMONA

Ø 450 mm

SIMONA
Ø 450 mm

8194
Page 178 | Full Face Stub Flange Long Spigot



8194
Page 179 | Stub Flange Long Spigot



8100
Page 180-181 | Concentric Reducer Long Spigot



8103/8193
Page 182 | Tee Long Spigot



8135/8223
Page 183 | Reducing Tee Long Spigot



8137
Page 184 | 45° Branches Long Spigot



8192
Page 184 | 90° Elbow Long Spigot



8192
Page 185 | 45° Elbow Long Spigot



8191
Page 186 | 90° Bend Long Spigot



8196
Page 187 | End Cap Long Spigot



8100
Page 188 | 11° Seamless Bend



8100
Page 189 | 22° Seamless Bend



8100
Page 190 | 30° Seamless Bend



8100
Page 191 | 45° Seamless Bend



8100
Page 192 | 60° Seamless Bend



8100
Page 193 | 90° Seamless Bend



8139
Page 194 | End Cap Short Spigot



8106
Page 195 | Stub Flange Short Spigot



8149
Page 196-198 | Concentric Reducer Short Spigot



8103
Page 199 | Tee Short Spigot



AS2129 Table D
Page 200-201 | Backing Flanges - AS2129 Table D (700kPa up to 50°C)

AS2129 Table E
Page 202-203 | Backing Flanges - AS2129 Table E (1400kPa up to 50°C)

AS4087 PN16
Page 204 | Backing Flanges - AS4087 PN16 (up to 80°C)

AS4087 PN21
Page 205 | Backing Flanges - AS4087 PN21 (up to 80°C)

AS4087 PN35
Page 206 | Backing Flanges - AS4087 PN35 (up to 80°C)

ASME B16.5 ANSI 150#
Page 207 | Backing Flanges - ASME B16.5 ANSI 150#

PLASSON is an exclusive distribution partner of

SIMONA

Global Thermoplastic Solutions

SIMONA AG is a top manufacturer and development partner of high-quality thermoplastic products, with production facilities and sales offices worldwide. They provide best-in-class solutions for the chemical process industry, water and energy utilities, commodity supply, mobility, environmental technology, and construction sectors.

SIMONA® Spigot Fittings are a hallmark of flexibility, durability, and functionality. Headquartered in Kirm, Germany, these fittings are crafted to high standards and available in sizes from DN20 to DN1200. For more details, visit www.simona.de.

Plasson, the exclusive Australian distributor, offers the widest range of SIMONA® Spigot Fittings, supported by expert technical, sales, and logistics teams to ensure you get the right product when and where you need it.

PLASSON PE100 HSCR Fittings
For ultimate crack resistance

SIMONA injection molded spigot fittings are made of PE100 HSCR (High Stress Crack Resistant)

PE100 HSCR is a PE100 material which offers up to ten times higher resistance to slow crack growth than regular PE100. This is particularly important where the pipe is prone to damage during installation. It has the same pressure burst strength of conventional PE100 pipe but is specially formulated for use in critical or high-value pipeline assets where the risk of premature failure from slow crack growth is possible.

RC resins are listed in PIPA POP016 guideline.

Benefits of PE100 HSCR:

- ✓ Produces a durable, hard-wearing pipeline
- ✓ Extends the service life of the entire piping system
- ✓ Enables cost-saving installation methods
- ✓ Maximum operational reliability

For more information on POP016 go to www.pipa.com.au/technical/pop-guidelines/

Stub Flange Systems

A typical stub flange system is shown below.

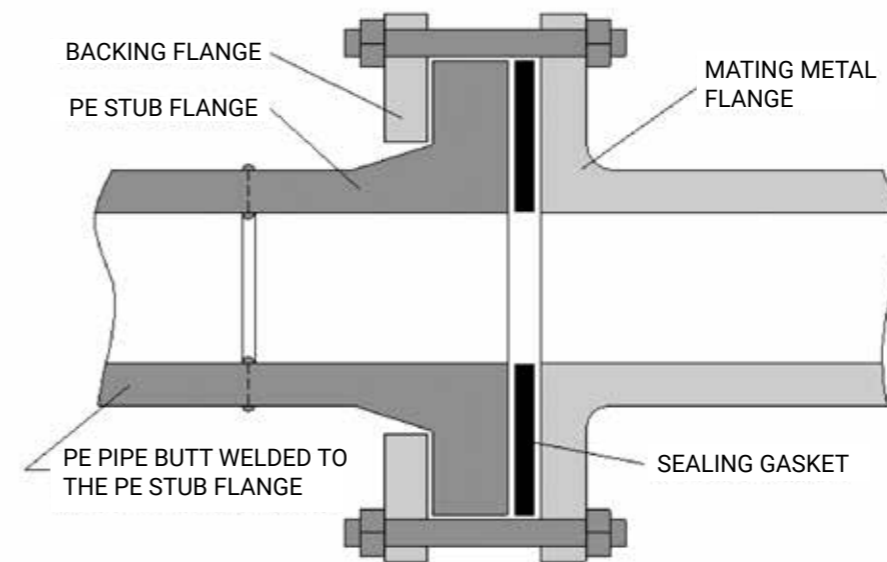

BOLT TYPE	NUT LENGTH	THREAD LENGTH
M12	10.8	27
M16	14.8	37
M20	18	45
M24	21.5	53.75
M27	24	60
M30	25.6	64
1/2"	10.8	27
5/8"	14.8	37

Plasson offers M12 bolts for 1/2" and M16 for 5/8".

Calculating the required bolt length of a stub flange system is dependent on the dimensions of the components shown in the above picture. This catalogue shows Stub (TS), Flange (TF) and Gasket (TG) thicknesses. Metric Bolts are used with Table D and E, PN16 and PN21 flanges. These bolts have a fixed thread length and selecting the right length of bolt is important to ensure the nut has sufficient length to tighten the system.

The **MINIMUM LENGTH** of the bolt must be greater than the thickness of all components combined while allowing sufficient thread for the nut to tighten onto.

$$LB - LT > TF + TS + TG + TM$$

The **MAXIMUM LENGTH** of the bolt must ensure that the nut doesn't bottom out on the thread of the bolt before sufficiently tightening the system. Usually 1.5x the nut length is allowed for tightening.

$$LB - (1.5 \times TN) < TF + TS + TG + TM$$

Metric Studs are typically used instead of bolts with PN35 flanges. Studs are threaded along the entire length and there is, therefore, no maximum length. The minimum length of the stud is determined by the same method as for bolts.

LENGTHS LISTED IN THIS CATALOGUE ARE THEORETICAL AND HAVE NOT MADE ANY PROVISION FOR SYSTEM COMPRESSION OR ANY TOLERANCES. PLEASE CONSULT THE RELEVANT STANDARDS TO ENSURE THAT THE SELECTED BOLTS ARE SUITABLE FOR YOUR APPLICATION.

PE FULL FACE FLANGES

Designed For Maximum Strength And Sealing

Features and Benefits:

- ✓ As4087, PN16 rated
- ✓ Injection moulded spigot conforms to AS/NZS 41
- ✓ Plasson SS 316L backing ring fully complies with the PIPA POP007 Guidelines
- ✓ Highest quality virgin PE100 HSCR resins for improved performance
- ✓ Long Spigot for Electrofusion or Butt Welding



Bolt Arrangement: Full Face Flange

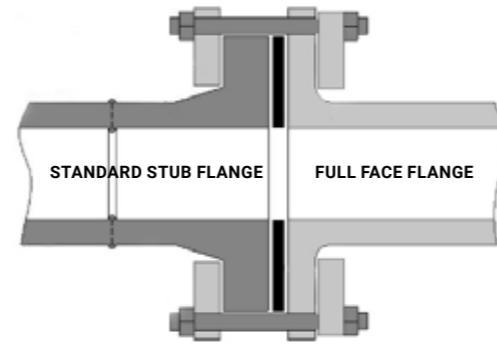

Full Face Stub Flange Long Spigot

8194

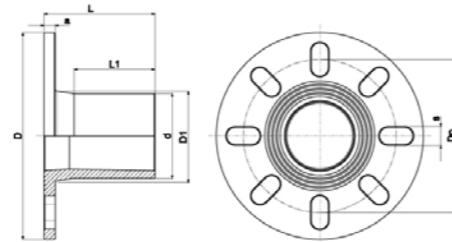

Product Code	Size d x DN	Z1	le1	d4	e	h1	d3	RF	SDR
4902007	90 x 3"	117	86	222	8.1	12	94	-	11
8194100	125 x 4"	173	120	215	11.4	27	132	154	11
8194101	180 x 6"	186	125	280	16.4	30	186	211	11
8194102	225 x 8"	260	185	335	20.5	36	235	268	11

Stub Flange Long Spigot

8194

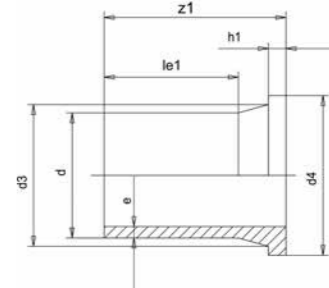

Product Code	Size d x Rp	Z1	le1	d4	e	h1	d3	SDR
8194035	20	85	62	45	2	7	27	11
8194036	25	90	62	58	2.3	9	33	11
8194001	32	86	62	68	3	10	40	11
8194002	40	89	62	72	3.7	11	50	11
8194003	50	90	62	82	4.6	12	60	11
8194004	63	106	70	94	5.8	14	75	11
8194005	75	129	94	105	6.8	16	89	11
8194006	90	140	100	125	8.2	17	105	11
8194007	110	160	113	158	10	18	125	11
8194008	125	170	116	158	11.4	25	132	11
8194009	140	182	128	188	12.7	25	155	11
8194010	160	208	155	212	14.6	25	175	11
8194011	180	202	168	212	16.4	30	186	11
8194012	200	206	140	268	18.2	32	232	11
8194013	225	201	135	268	20.5	32	235	11
8194014	250	225	143	320	22.7	35	285	11
8194015	280	235	155	320	25.4	35	291	11
8194016	315	250	170	370	28.6	35	335	11
8194017	355	260	176	430	32.2	40	373	11
8194018	400	290	195	482	36.3	46	427	11
8100515	450	335	210	556	40.9	60	462	11
8100516	500	350	230	585	45.4	60	532	11
8100517	560	370	240	665	50.8	60	615	11
8100518	630	390	260	685	57.2	60	643	11
8100561	710	450	300	800	64.5	70	737	11
8194019	50	90	62	82	3	12	60	17
8194020	63	106	70	94	3.8	14	75	17
8194021	75	130	92	105	4.5	16	89	17
8194022	90	140	100	125	5.4	17	105	17
8194023	110	158	113	158	6.6	18	125	17
8194024	125	170	122	158	7.4	18	132	17
8194025	140	173	130	188	8.3	18	153	17
8194026	160	208	160	212	9.5	18	175	17
8194027	180	200	140	212	10.7	20	186	17
8194028	200	199	133	268	11.9	24	232	17
8194029	225	201	135	268	13.4	24	235	17
8194030	250	225	156	320	14.8	25	285	17
8194031	280	236	167	320	16.6	25	291	17
8194032	315	250	180	370	18.7	25	335	17
8194033	355	261	179	430	21.1	30	373	17
8194034	400	290	195	482	23.7	33	427	17
8100519	450	335	225	556	26.7	46	462	17
8100520	500	350	240	585	29.7	46	532	17
8100521	560	370	250	665	33.2	50	615	17
8100522	630	390	270	685	37.4	50	644	17
8100558	710	450	300	800	42.1	50	737	17
8100559	800	470	320	905	47.4	54	840	17
8100560	900	505	350	1005	53.3	58	944	17

Concentric Reducer Long Spigot

8100

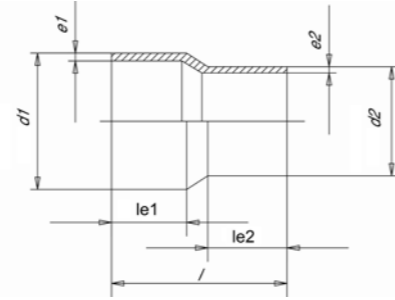

Product Code	Size d1 x d2	le1	le2	l	e1	e2	SDR
8100208	25 X 20	41	41	90	2.3	1.9	11
8100209	32 X 20	44	41	101	3	2	11
8100210	32 X 25	44	41	100	3	2.3	11
8100211	40 X 25	49	41	104	3.7	2.3	11
8100141	40 X 32	49	44	105	3.7	2.9	11
8100142	50 X 25	56	42	132	4.6	2.3	11
8100143	50 X 32	57	47	132	4.6	2.9	11
8100144	50 X 40	55	51	134	4.6	3.7	11
8100145	63 X 32	63	44	144	5.8	2.9	11
8100146	63 X 40	63	49	147	5.8	3.7	11
8100147	63 X 50	64	58	152	5.8	4.6	11
8100148	75 X 50	70	55	155	6.8	4.6	11
8100149	75 X 63	70	65	171	6.8	5.8	11
8100150	90 X 50	79	57	174	8.2	4.6	11
8100151	90 X 63	79	70	182	8.2	5.8	11
8100152	90 X 75	79	70	180	8.2	6.8	11
8100153	110 X 63	84	69	185	10	5.8	11
8100154	110 X 75	84	74	185	10	6.8	11
8100155	110 X 90	84	81	186	10	8.2	11
8100156	125 X 63	91	69	200	11.4	5.8	11
8100157	125 X 90	91	80	202	11.4	8.2	11
8100158	125 X 110	90	90	200	11.4	10	11
8100159	140 X 90	112	86	237	12.7	8.2	11
8100160	140 X 110	116	90	230	12.7	10	11
8100161	140 X 125	117	96	235	12.7	11.4	11
8100162	160 X 90	109	84	254	14.6	8.2	11
8100163	160 X 110	110	89	254	14.6	10	11
8100164	160 X 125	110	95	254	14.6	11.4	11
8100165	160 X 140	110	106	254	14.6	12.7	11
8100166	180 X 90	106	79	245	16.4	8.2	11
8100167	180 X 110	124	93	275	16.4	10	11
8100168	180 X 125	105	87	245	16.4	11.4	11
8100169	180 X 160	126	125	279	16.4	14.6	11
8100170	200 X 140	123	114	279	18.2	12.7	11
8100171	200 X 160	122	122	277	18.2	14.6	11
8100172	200 X 180	126	120	279	18.2	16.4	11
8100173	225 X 160	132	123	295	20.5	14.6	11
8100174	225 X 180	130	118	285	20.5	16.4	11
8100175	225 X 200	126	120	272	20.5	18.2	11
8100176	250 X 160	149	100	308	22.7	14.6	11
8100177	250 X 180	151	105	316	22.7	16.4	11
8100178	250 X 200	151	116	324	22.7	18.2	11
8100179	250 X 225	155	122	330	22.7	20.5	11
8100180	280 X 200	140	116	345	25.4	18.2	11
8100181	280 X 225	142	122	335	25.4	20.5	11
8100182	280 X 250	139	135	340	25.4	22.7	11
8100183	315 X 225	150	125	365	28.6	20.5	11
8100184	315 X 250	150	134	365	28.6	22.7	11
8100185	315 X 280	150	145	365	28.6	25.4	11
8149105	63 X 32	63	46	142	3.8	2.9	17
8149107	63 X 50	64	58	152	3.8	3	17
8149108	75 X 63	70	63	166	4.5	3.8	17
8149110	90 X 63	79	63	182	5.4	3.8	17
8149111	90 X 75	80	73	185	5.4	4.5	17
8149112	110 X 63	84	69	185	6.6	3.8	17
8149113	110 X 75	83	73	183	6.6	4.5	17

Concentric Reducer Long Spigot Cont.

8100

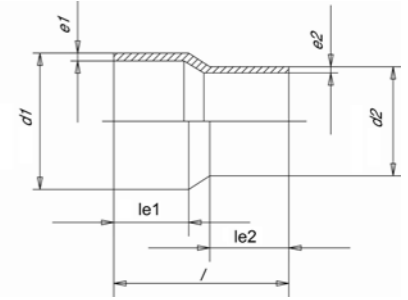

Product Code	Size d1 x d2	le1	le2	l	e1	e2	SDR
8149114	110 X 90	83	80	185	6.6	5.4	17
8149115	125 X 63	90	68	200	7.4	3.8	17
8149116	125 X 90	90	81	200	7.4	5.4	17
8149117	125 X 110	91	90	200	7.4	6.6	17
8149118	140 X 90	112	86	235	8.3	5.4	17
8149119	140 X 110	114	91	237	8.3	6.6	17
8149120	140 X 125	117	96	235	8.3	7.4	17
8149122	160 X 110	110	89	254	9.5	6.6	17
8149121	160 X 90	109	84	254	9.5	5.4	17
8149123	160 X 125	110	95	254	9.5	7.4	17
8149124	160 X 140	110	106	254	9.5	8.3	17
8149125	180 X 90	105	80	244	10.7	5.4	17
8149126	180 X 110	124	93	275	10.7	6.6	17
8149127	180 X 125	105	87	250	10.7	7.4	17
8149128	180 X 140	123	114	277	10.7	8.3	17
8149129	180 X 160	126	125	279	10.7	9.5	17
8149130	200 X 140	123	114	279	11.9	8.3	17
8149131	200 X 160	122	124	278	11.9	9.5	17
8149132	200 X 180	126	120	279	11.9	10.7	17
8149133	225 X 140	133	114	290	13.4	8.3	17
8149134	225 X 160	134	123	295	13.4	9.5	17
8149135	225 X 180	125	118	275	13.4	10.7	17
8149136	225 X 200	126	120	272	13.4	11.9	17
8149137	250 X 160	151	98	308	14.8	9.5	17
8149138	250 X 180	153	105	316	14.8	10.7	17
8149139	250 X 200	154	113	325	14.8	11.9	17
8149140	250 X 225	155	122	330	14.8	13.4	17
8149141	280 X 200	142	116	330	16.6	11.9	17
8149142	280 X 225	140	124	335	16.6	13.4	17
8149143	280 X 250	139	134	340	16.6	14.8	17
8149144	315 X 225	152	125	371	18.7	13.4	17
8149145	315 X 250	151	133	367	18.7	14.8	17
8149146	315 X 280	150	140	369	18.7	16.6	17
8149147	355 X 250	164	129	390	21.1	14.8	17
8149148	355 X 280	164	139	390	21.1	16.6	17
8149149	355 X 315	164	150	340	21.1	18.7	17
8149150	400 X 280	179	139	415	23.7	16.6	17
8149151	400 X 315	179	150	415	23.7	18.7	17
8149152	400 X 355	179	164	420	23.7	21.1	17
8149153	450 X 280	205	140	390	26.7	16.6	17
8149154	450 X 315	195	150	390	26.7	18.7	17
8149155	450 X 355	195	165	395	26.7	21.1	17
8149156	450 X 400	205	180	400	26.7	23.7	17
8149157	500 X 315	212	150	425	29.7	18.7	17
8149158	500 X 355	225	165	430	29.7	21.1	17
8149159	500 X 400	225	180	430	29.7	23.7	17
8149160	500 X 450	225	195	430	29.7	26.7	17
8149161	560 X 355	240	165	460	33.2	21.1	17
8149162	560 X 400	240	180	470	33.2	23.7	17
8149163	560 X 450	240	195	470	33.2	26.7	17
8149164	560 X 500	240	215	470	33.2	29.7	17
8149165	630 X 400	260	180	510	37.4	23.7	17
8149166	630 X 450	260	195	510	37.4	26.7	17
8149167	630 X 500	260	215	510	37.4	29.7	17
8149168	630 X 560	260	235	520	37.4	33.2	17

Tee Long Spigot

8103/8193

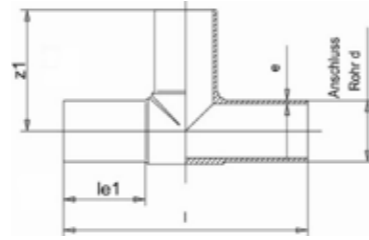

Product Code	d	z1	le1	Length	e	SDR
8103084	25	60	41	120	2.3	11
8103053	32	67	46	139	2.9	11
8103054	40	82	52	165	3.7	11
8103055	50	92	57	184	4.6	11
8103056	63	105	65	216	5.8	11
8103057	75	122	72	248	6.8	11
8103058	90	137	80	277	8.2	11
8103059	110	162	88	321	10	11
8103060	125	176	98	350	11.4	11
8103061	140	200	104	399	12.7	11
8103062	160	206	104	413	14.6	11
8103063	180	260	143	528	16.4	11
8103064	200	253	124	505	18.2	11
8103065	225	278	129	559	20.5	11
8103066	250	291	132	582	22.7	11
8103067	280	312	133	622	25.4	11
8103068	315	351	153	690	28.6	11
8193001	355	414	167	829	32.2	11
8193002	400	457	198	913	36.3	11
8193003	450	477	198	954	40.9	11
8193004	500	525	218	1050	45.4	11
8100546	560	600	245	1200	50.8	11
8100547	630	650	265	1300	57.2	11
8103069	50	90	57	184	3	17
8103070	63	106	64	214	3.8	17
8103071	75	122	72	246	4.5	17
8103072	90	137	81	277	5.4	17
8103073	110	161	84	321	6.6	17
8103074	125	174	100	345	7.4	17
8103075	140	197	104	395	8.3	17
8103076	160	206	104	410	9.5	17
8103077	180	260	141	525	10.7	17
8103078	200	250	123	501	11.9	17
8103079	225	276	129	555	13.4	17
8103080	250	288	132	576	14.8	17
8103081	280	309	132	617	16.6	17
8103082	315	346	153	695	18.7	17
8193005	355	408	165	818	21.1	17
8193006	400	455	197	910	23.7	17
8193007	450	478	197	955	26.7	17
8193008	500	525	218	1050	29.7	17
8100544	560	623	245	1246	33.2	17
8100545	630	675	265	1350	37.4	17

Reducing Tee Long Spigot

8135/8223

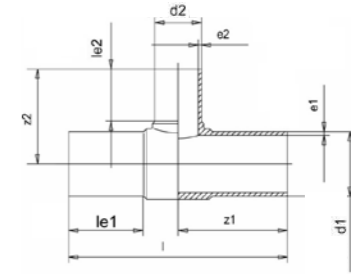

Product Code	d1 x d2	z1	z2	le1	le2	l	e1	e2	SDR
8223019	63 X 32	109	86	65	47	218	5.8	3	11
8223020	63 X 40	109	93	65	52	218	5.8	3.7	11
8135030	63 X 50	108	103	63	56	215	5.8	4.6	11
8135031	75 X 32	128	108	70	46	256	6.8	2.9	11
8135032	75 X 50	127	113	70	56	253	6.8	4.6	11
8135033	75 X 63	128	117	70	63	255	6.8	5.8	11
8135021	90 X 50	135	120	81	59	280	8.2	4.6	11
8135022	90 X 63	141	127	81	65	282	8.2	5.8	11
8135034	90 X 75	136	138	73	68	272	8.2	6.8	11
8135023	110 X 63	162	148	88	67	322	10	5.8	11
8135035	110 X 75	155	151	82	70	309	10	6.8	11
8135024	110 X 90	161	164	88	82	322	10	8.2	11
8135036	125 X 110	171	170	90	83	341	11.4	10	11
8135037	160 X 63	208	174	105	65	416	14.6	5.8	11
8135025	160 X 90	206	190	104	83	415	14.6	8.2	11
8135026	160 X 110	207	200	104	89	414	14.6	10	11
8223017	180 X 90	238	200	108	82	476	16.4	8.2	11
8223018	180 X 110	240	202	107	84	480	16.4	10	11
8135039	180 X 160	240	220	110	101	480	16.4	14.6	11
8223001	200 X 90	250	216	124	82	500	18.2	8.2	11
8223002	200 X 110	253	219	124	86	505	18.2	10	11
8223003	200 X 160	253	237	120	101	500	18.2	14.6	11
8135040	225 X 75	280	219	129	73	560	20.5	6.8	11
8135027	225 X 90	275	228	129	82	555	20.5	8.2	11
8135028	225 X 110	278	238	130	86	559	20.5	10	11
8135029	225 X 160	277	258	128	107	556	20.5	14.6	11
8135041	225 X 180	280	284	130	108	559	20.5	16.4	11
8223007	250 X 110	288	248	133	85	584	22.7	10	11
8223008	250 X 160	292	266	134	102	586	22.7	14.6	11
8223005	315 X 110	346	282	155	85	706	28.6	10	11
8223006	315 X 160	352	301	155	101	705	28.6	14.6	11
8223035	315 X 200	320	326	170	126	640	28.6	18.2	11
8223036	315 X 225	319	335	170	145	638	28.6	20.5	11
8223004	315 X 250	346	331	154	135	695	28.6	22.7	11
8135051	63 X 50	108	103	61	56	217	3.8	3	17
8135052	75 X 50	126	109	68	56	252	4.5	3	17
8135053	75 X 63	126	116	69	62	252	4.5	3.8	17
8135044	90 X 50	139	118	80	59	278	5.4	3	17
8135045	90 X 63	135	127	81	65	275	5.4	3.8	17
8135054	90 X 75	136	139	74	71	272	5.4	4.5	17
8135046	110 X 63	162	147	88	67	320	6.6	3.8	17
8135055	110 X 75	158	152	84	70	315	6.6	4.5	17
8135047	110 X 90	154	160	86	81	318	6.6	5.4	17
8135056	125 X 110	167	168	84	83	334	7.4	6.6	17
8135057	160 X 63	205	172	103	65	411	9.5	3.8	17
8135058	160 X 75	172	180	98	74	343	9.5	4.5	17
8135048	160 X 90	206	190	104	82	412	9.5	5.4	17
8135049	160 X 110	206	198	103	88	412	9.5	6.6	17
8223044	180 X 90	210	200	136	97	420	10.7	5.4	17
8135059	180 X 160	200	205	105	94	411	10.7	9.5	17
8223009	200 X 90	253	216	125	82	504	11.9	5.4	17
8223010	200 X 110	254	219	124	85	506	11.9	6.6	17
8223011	200 X 160	255	235	120	101	500	11.9	9.5	17
8135060	225 X 75	279	219	129	72	561	13.4	4.5	17
8135050	225 X 90	276	226	129	82	555	13.4	5.4	17
8135042	225 X 110	277	236	130	86	556	13.4	6.6	17
8135043	225 X 160	277	255	128	107	555	13.4	9.5	17
8135061	225 X 180	281	284	128	107	558	13.4	10.7	17
8223014	250 X 110	288	242	133	85	580	14.8	6.6	17
8223015	250 X 160	288	261	133	101	580	14.8	9.5	17
8223012	315 X 110	350	277	155	84	699	18.7	6.6	17
8223013	315 X 160	349	300	153	102	695	18.7	9.5	17
8223050	315 X 200	320	331	170	129.5	640	18.7	11.9	17
8223051	315 X 225	319	335	170	145	638	18.7	13.4	17
8223016	315 X 250	349	329	154	135	695	18.7	14.8	17

RURAL COMPRESSION
THREADED FITTINGS
METRIC COMPRESSION
TAPPING SADDLES
VALVES
ELECTROFUSION
TOOLING
SIMONA SPIGOTS
ASSEMBLY INSTRUCTIONS

45° Branches Long Spigot

8137

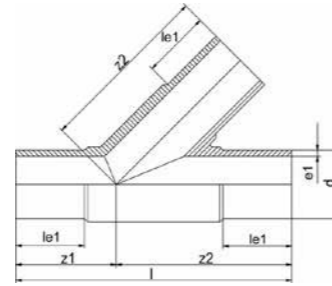

Product Code	d	z1	z2	le1	l	e	SDR
8137001	63	97	162	69	259	5.8	11
8137002	75	109	190	77	299	6.8	11
8137003	90	137	230	85	367	8.2	11
8137004	110	137	260	90	397	10	11
8137005	63	94	162	70	256	3.8	17
8137006	75	109	190	77	299	4.5	17
8137007	90	135	230	85	365	5.4	17
8137008	110	139	260	90	399	6.6	17

90° Elbow Long Spigot

8192

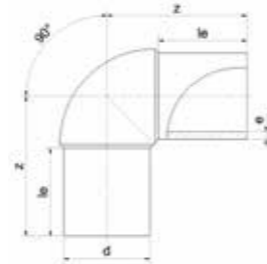

Product Code	d	e	z	le	SDR
8192061	20	2	73	52	11
8192062	25	2.3	80	56	11
8192031	32	3	95	70	11
8192032	40	3.7	105	74	11
8192033	50	4.6	108	80	11
8192034	63	5.8	117	80	11
8192035	75	6.8	132	90	11
8192036	90	8.2	142	91	11
8192037	110	10	162	99	11
8192038	125	11.4	169	103	11
8192039	140	12.7	200	120	11
8192040	160	14.6	233	142	11
8192041	180	16.4	247	142	11
8192042	200	18.2	262	153	11
8192043	225	20.5	281	154	11
8192044	250	22.7	293	134	11
8192045	280	25.4	330	144	11
8192046	315	28.6	370	154	11
8192047	50	3	108	80	17
8192048	63	3.8	116	80	17
8192049	75	4.5	129	89	17
8192050	90	5.4	143	90	17
8192051	110	6.6	160	99	17
8192052	125	7.4	171	102	17
8192053	140	8.3	200	120	17
8192054	160	9.5	230	141	17
8192055	180	10.7	243	141	17
8192056	200	11.9	263	152	17
8192057	225	13.4	277	153	17
8192058	250	14.8	293	134	17
8192059	280	16.6	325	144	17
8192060	315	18.7	370	153	17

45° Elbow Long Spigot

8192

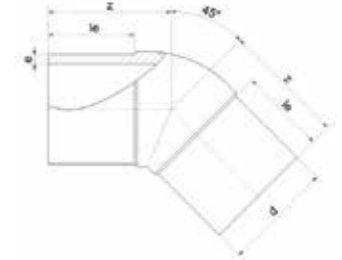

Product Code	d	z	le	e	SDR
8192063	20	72	52	1.9	11
8192064	25	75	57	2.3	11
8192001	32	90	71	3	11
8192002	40	95	74	3.7	11
8192003	50	76	62	4.6	11
8192004	63	88	66	5.8	11
8192005	75	90	71	6.8	11
8192006	90	105	83	8.2	11
8192007	110	121	93	10	11
8192008	125	137	99	11.4	11
8192009	140	168	121	12.7	11
8192010	160	190	142	14.6	11
8192011	180	196	141	16.4	11
8192012	200	207	153	18.2	11
8192013	225	210	154	20.5	11
8192014	250	220	133	22.7	11
8192015	280	227	144	25.4	11
8192016	315	250	155	28.6	11
8192017	50	76	61	3	17
8192018	63	88	65	3.8	17
8192019	75	90	71	4.5	17
8192020	90	105	83	5.4	17
8192021	110	121	91	6.6	17
8192022	125	137	97	7.4	17
8192023	140	168	120	8.3	17
8192024	160	190	142	9.5	17
8192025	180	196	141	10.7	17
8192026	200	207	152	11.9	17
8192027	225	210	153	13.4	17
8192028	250	220	133	14.8	17
8192029	280	227	142	16.6	17
8192030	315	250	154	18.7	17

90° Bend Long Spigot

8191

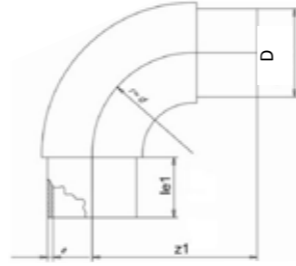

Product Code	d	z1	le1	e	SDR
8191001	32	79	48	3	11
8191002	40	92	52	3.7	11
8191003	50	107	59	4.6	11
8191004	63	131	69	5.8	11
8191005	75	153	76	6.8	11
8191006	90	173	83	8.2	11
8191007	110	195	84	10	11
8191008	125	216	92	11.4	11
8191009	140	237	96	12.7	11
8191010	160	262	103	14.6	11
8191011	180	294	115	16.4	11
8191012	200	317	122	18.2	11
8191013	225	351	131	20.5	11
8191014	250	382	133	22.7	11
8191015	280	432	153	25.4	11
8191016	315	471	154	28.6	11
8191035	355	560	180	32.2	11
8191037	400	625	190	36.3	11
8191031	450	645	195	40.9	11
8191032	500	710	212	45.4	11
8191017	50	108	59	3	17
8191018	63	130	67	3.8	17
8191019	75	153	76	4.5	17
8191020	90	173	83	5.4	17
8191021	110	195	84	6.6	17
8191022	125	216	92	7.4	17
8191023	140	237	97	8.3	17
8191024	160	262	103	9.5	17
8191025	180	290	113	10.7	17
8191026	200	317	122	11.9	17
8191027	225	350	130	13.4	17
8191028	250	382	134	14.8	17
8191029	280	430	154	16.6	17
8191030	315	465	153	18.7	17
8191036	355	560	180	20.1	17.6
8191038	400	625	190	22.7	17.6
8191033	450	645	195	26.7	17
8191034	500	710	212	29.7	17

End Cap Long Spigot

8196

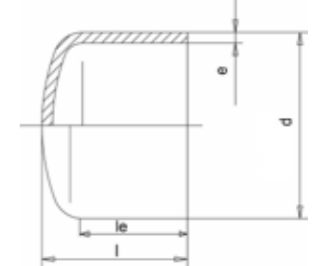

Product Code	d	le	L	e	SDR
8196011	20	41	49	1.9	11
8196012	25	41	50	2.3	11
8139021	32	46	56	2.9	11
8139022	40	49	61	3.7	11
8139023	50	58	71	4.6	11
8139024	63	66	84	5.8	11
8139025	75	73	94	6.8	11
8139026	90	82	109	8.2	11
8139027	110	88	122	10	11
8139028	125	93	128	11.4	11
8139029	140	97	136	12.7	11
8139030	160	108	156	14.6	11
8139031	180	113	167	16.4	11
8139032	200	117	180	18.2	11
8139033	225	127	203	20.5	11
8196001	250	138	217	22.7	11
8196002	280	151	239	25.4	11
8196003	315	158	256	28.6	11
8196004	355	175	291	32.2	11
8196005	400	193	316	36.3	11
8100073	450	210	300	40.9	11
8100074	500	240	325	45.4	11
8100075	560	260	360	50.8	11
8100076	630	295	400	57.2	11
8139034	50	59	70	3	17
8139035	63	66	83	3.8	17
8139036	75	72	94	4.5	17
8139037	90	81	109	5.4	17
8139038	110	88	121	6.6	17
8139039	125	92	127	7.4	17
8139040	140	97	136	8.3	17
8139041	160	107	155	9.5	17
8139042	180	114	166	10.7	17
8139043	200	117	179	11.9	17
8139044	225	127	203	13.4	17
8196006	250	140	216	14.8	17
8196007	280	149	238	16.6	17
8196008	315	158	258	18.7	17
8196009	355	175	281	21.1	17
8196010	400	195	310	23.7	17
8100077	450	220	300	26.7	17
8100078	500	230	315	29.7	17
8100079	560	240	340	33.2	17
8100080	630	270	370	37.4	17

11° Seamless Bend

8100

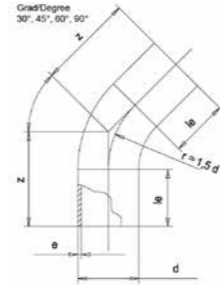

Product Code	d	z	le	d	e	SDR
8100001	110	219	150	110	15.1	7.4
8100002	160	239	150	160	21.9	7.4
8100003	225	266	150	225	30.8	7.4
8100004	315	460	250	315	43.1	7.4
8101001	32	98	70	32	2.9	11
8101002	40	106	75	40	3.7	11
8101003	50	130	80	50	4.6	11
8101004	63	150	90	63	5.8	11
8101005	75	155	100	75	6.8	11
8101006	90	210	100	90	8.2	11
8101531	110	234	120	110	10	11
8101532	125	225	150	125	11.4	11
8101533	140	231	150	140	12.7	11
8101534	160	239	150	160	14.6	11
8101535	180	247	150	180	16.4	11
8101536	200	255	150	200	18.2	11
8101007	225	266	150	225	20.5	11
8101008	250	385	250	250	22.7	11
8101009	280	400	250	280	25.4	11
8101010	315	460	250	315	28.6	11
8101011	355	540	300	355	32.2	11
8101012	400	560	300	400	36.3	11
8101013	450	580	300	450	40.9	11
8101014	500	650	350	500	45.4	11
8101015	560	680	350	560	50.8	11
8101016	630	730	350	630	57.2	11
8101537	710	900	400	710	64.5	11
8101538	800	950	400	800	72.6	11
8101017	50	140	80	50	3	17
8101018	63	150	90	63	3.8	17
8101019	75	155	100	75	4.5	17
8101020	90	180	100	90	5.4	17
8101021	110	219	120	110	6.6	17
8101022	125	225	150	125	7.4	17
8101023	140	231	150	140	8.3	17
8101024	160	239	150	160	9.5	17
8101025	180	247	150	180	10.7	17
8101026	200	255	150	200	11.9	17
8101027	225	266	150	225	13.4	17
8101028	250	385	250	250	14.8	17
8101029	280	400	250	280	16.6	17
8101030	315	460	250	315	18.7	17
8101031	355	540	300	355	21.1	17
8101032	400	560	300	400	23.7	17
8101033	450	580	300	450	26.7	17
8101034	500	650	350	500	29.7	17
8101035	560	680	350	560	33.2	17
8101036	630	730	350	630	37.4	17
8101539	710	900	400	710	42.1	17
8101540	800	950	400	800	47.4	17
8100005	900	1150	450	900	53.3	17
8100006	1000	1200	450	1000	59.3	17

22° Seamless Bend

8100

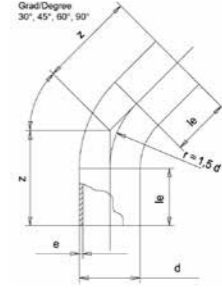

Product Code	d	z	le	e	SDR
8100007	110	219	150	15.1	7.4
8100008	160	239	150	21.9	7.4
8100009	225	266	150	30.8	7.4
8100010	315	460	250	43.1	7.4
8101037	32	98	70	2.9	11
8101038	40	106	75	3.7	11
8101039	50	130	80	4.6	11
8101040	63	150	90	5.8	11
8101041	75	155	100	6.8	11
8101042	90	210	100	8.2	11
8101043	110	234	120	10	11
8101044	125	225	150	11.4	11
8101045	140	231	150	12.7	11
8101046	160	239	150	14.6	11
8101047	180	247	150	16.4	11
8101048	200	255	150	18.2	11
8101049	225	266	150	20.5	11
8101050	250	385	250	22.7	11
8101051	280	400	250	25.4	11
8101052	315	460	250	28.6	11
8101053	355	540	300	32.2	11
8101054	400	560	300	36.3	11
8101055	450	580	300	40.9	11
8101056	500	650	350	45.4	11
8101057	560	680	350	50.8	11
8101058	630	730	350	57.2	11
8100011	710	900	400	64.5	11
8100012	800	950	400	72.6	11
8101059	50	140	80	3	17
8101060	63	150	90	3.8	17
8101061	75	155	100	4.5	17
8101062	90	180	100	5.4	17
8101063	110	219	120	6.6	17
8101064	125	225	150	7.4	17
8101065	140	231	150	8.3	17
8101066	160	239	150	9.5	17
8101067	180	247	150	10.7	17
8101068	200	255	150	11.9	17
8101069	225	266	150	13.4	17
8101070	250	385	250	14.8	17
8101071	280	400	250	16.6	17
8101072	315	460	250	18.7	17
8101073	355	540	300	21.1	17
8101074	400	560	300	23.7	17
8101075	450	580	300	26.7	17
8101076	500	650	350	29.7	17
8101077	560	680	350	33.2	17
8101078	630	730	350	37.4	17
8100013	710	900	400	42.1	17
8100014	800	950	400	47.4	17
8100015	900	1150	450	53.3	17
8100016	1000	1200	450	59.3	17

30° Seamless Bend

8100

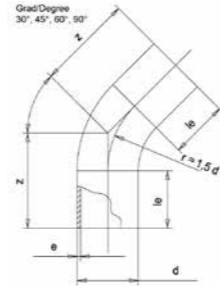

Product Code	d	z	le	e	SDR
8100021	110	219	150	15.1	7.4
8100022	160	239	150	21.9	7.4
8100024	315	460	250	43.1	7.4
8100023	225	266	150	30.8	7.4
8101138	32	98	70	2.9	11
8101139	40	106	75	3.7	11
8101140	50	130	80	4.6	11
8101141	63	150	90	5.8	11
8101142	75	155	100	6.8	11
8101143	90	210	100	8.2	11
8101144	110	234	120	10	11
8101145	125	225	150	11.4	11
8101146	140	231	150	12.7	11
8101147	160	239	150	14.6	11
8101148	180	247	150	16.4	11
8101149	200	255	150	18.2	11
8101150	225	266	150	20.5	11
8101151	250	385	250	22.7	11
8101152	280	400	250	25.4	11
8101153	315	460	250	28.6	11
8101154	355	540	300	32.2	11
8101155	400	560	300	36.3	11
8101156	450	580	300	40.9	11
8101157	500	650	350	45.4	11
8101158	560	680	350	50.8	11
8101159	630	730	350	57.2	11
8100025	710	900	400	64.5	11
8100026	800	950	400	72.6	11
8101160	50	140	80	3	17
8101161	63	150	90	3.8	17
8101162	75	155	100	4.5	17
8101163	90	180	100	5.4	17
8101164	110	219	120	6.6	17
8101165	125	225	150	7.4	17
8101166	140	231	150	8.3	17
8101167	160	239	150	9.5	17
8101168	180	247	150	10.7	17
8101169	200	255	150	11.9	17
8101170	225	266	150	13.4	17
8101171	250	385	250	14.8	17
8101172	280	400	250	16.6	17
8101173	315	460	250	18.7	17
8101174	355	540	300	21.1	17
8101175	400	560	300	23.7	17
8101176	450	580	300	26.7	17
8101177	500	650	350	29.7	17
8101178	560	680	350	33.2	17
8101179	630	730	350	37.4	17
8100027	710	900	400	42.1	17
8100028	800	950	400	47.4	17
8100029	900	1150	450	53.3	17
8100030	1000	1200	450	59.3	17

45° Seamless Bend

8100

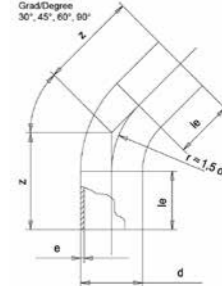

Product Code	d	z	le	e	SDR
8100035	110	243	150	15.1	7.4
8100036	160	274	150	21.9	7.4
8100037	225	315	150	30.8	7.4
8100038	315	535	250	43.1	7.4
8101239	32	105	70	2.9	11
8101240	40	110	75	3.7	11
8101241	50	139	80	4.6	11
8101242	63	161	90	5.8	11
8101243	75	168	100	6.8	11
8101244	90	227	100	8.2	11
8101245	110	255	120	10	11
8101246	125	253	150	11.4	11
8101247	140	262	150	12.7	11
8101248	160	274	150	14.6	11
8101249	180	287	150	16.4	11
8101250	200	299	150	18.2	11
8101251	225	315	150	20.5	11
8101252	250	440	250	22.7	11
8101253	280	460	250	25.4	11
8101254	315	535	250	28.6	11
8101255	355	620	300	32.2	11
8101256	400	650	300	36.3	11
8101257	450	680	300	40.9	11
8101258	500	760	350	45.4	11
8101259	560	800	350	50.8	11
8101260	630	870	350	57.2	11
8100039	710	900	400	64.5	11
8100040	800	950	400	72.6	11
8101261	50	149	80	3	17
8101262	63	161	90	3.8	17
8101263	75	168	100	4.5	17
8101264	90	197	100	5.4	17
8101265	110	243	120	6.6	17
8101266	125	253	150	7.4	17
8101267	140	262	150	8.3	17
8101268	160	274	150	9.5	17
8101269	180	287	150	10.7	17
8101270	200	299	150	11.9	17
8101271	225	315	150	13.4	17
8101272	250	440	250	14.8	17
8101274	315	535	250	18.7	17
8101275	355	620	300	21.1	17
8101276	400	650	300	23.7	17
8101277	450	680	300	26.7	17
8101278	500	760	350	29.7	17
8101279	560	800	350	33.2	17
8101280	630	870	350	37.4	17
8100041	710	900	400	42.1	17
8100042	800	950	400	47.4	17
8100043	900	1150	450	53.3	17
8100044	1000	1200	450	59.3	17

60° Seamless Bend

8100

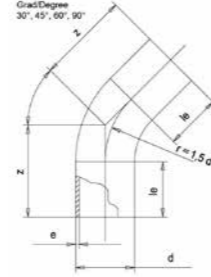

Products Code	d	z	le	e	SDR
8100049	110	270	150	15.1	7.4
8100050	160	313	150	21.9	7.4
8100051	225	370	150	30.8	7.4
8100052	315	612	250	43.1	7.4
8101340	32	113	70	2.9	11
8101341	40	125	75	3.7	11
8101342	50	158	80	4.6	11
8101343	63	173	90	5.8	11
8101344	75	182	100	6.8	11
8101345	90	243	100	8.2	11
8101346	110	270	120	10	11
8101347	125	283	150	11.4	11
8101348	140	296	150	12.7	11
8101349	160	313	150	14.6	11
8101350	180	330	150	16.4	11
8101351	200	348	150	18.2	11
8101352	225	370	150	20.5	11
8101353	250	500	250	22.7	11
8101354	280	530	250	25.4	11
8101355	315	612	250	28.6	11
8101356	355	690	300	32.2	11
8101357	400	730	300	36.3	11
8101358	450	780	300	40.9	11
8101359	500	880	350	45.4	11
8101360	560	930	350	50.8	11
8101361	630	1000	350	57.2	11
8100053	710	1150	400	64.5	11
8100054	800	1250	400	72.6	11
8101362	50	158	80	3	17
8101363	63	173	90	3.8	17
8101364	75	182	100	4.5	17
8101365	90	213	100	5.4	17
8101366	110	270	120	6.6	17
8101367	125	283	150	7.4	17
8101368	140	296	150	8.3	17
8101369	160	313	150	9.5	17
8101370	180	330	150	10.7	17
8101371	200	348	150	11.9	17
8101372	225	370	150	13.4	17
8101373	250	500	250	14.8	17
8101374	280	530	250	16.6	17
8101375	315	612	250	18.7	17
8101376	355	690	300	21.1	17
8101377	400	730	300	23.7	17
8101378	450	780	300	26.7	17
8101379	500	880	350	29.7	17
8101380	560	930	350	33.2	17
8101381	630	1000	350	37.4	17
8100055	710	1150	400	42.1	17
8100056	800	1250	400	47.4	17
8100057	900	1450	450	53.3	17
8100058	1000	1600	450	59.3	17

90° Seamless Bend

8100

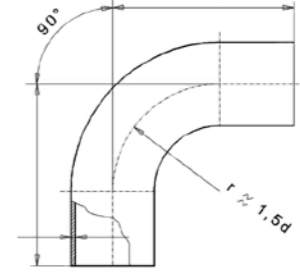

Product Code	d	z	le	e	SDR
8100063	110	340	150	15.1	7.4
8100064	160	415	150	21.9	7.4
8100065	225	513	150	30.8	7.4
8100066	315	803	250	43.1	7.4
8101489	32	133	70	2.9	11
8101490	40	150	75	3.7	11
8101491	50	185	80	4.6	11
8101492	63	220	90	5.8	11
8101493	75	238	100	6.8	11
8101494	90	310	100	8.2	11
8101495	110	315	120	10	11
8101496	125	363	150	11.4	11
8101497	140	385	150	12.7	11
8101498	160	415	150	14.6	11
8101499	180	445	150	16.4	11
8101500	200	475	150	18.2	11
8101501	225	513	150	20.5	11
8101502	250	650	250	22.7	11
8101503	280	695	250	25.4	11
8101504	315	803	250	28.6	11
8101505	355	900	300	32.2	11
8101506	400	980	300	36.3	11
8101507	450	1070	300	40.9	11
8101508	500	1200	350	45.4	11
8101509	560	1290	350	50.8	11
8101510	630	1400	350	57.2	11
8100067	710	1415	400	64.5	11
8100068	800	1550	400	72.6	11
8101511	50	195	80	3	17
8101512	63	220	90	3.8	17
8101513	75	238	100	4.5	17
8101514	90	280	100	5.4	17
8101515	110	340	120	6.6	17
8101516	125	363	150	7.4	17
8101517	140	385	150	8.3	17
8101518	160	415	150	9.5	17
8101519	180	445	150	10.7	17
8101520	200	475	150	11.9	17
8101521	225	513	150	13.4	17
8101522	250	650	250	14.8	17
8101524	315	803	250	18.7	17
8101525	355	900	300	21.1	17
8101526	400	980	300	23.7	17
8101527	450	1070	300	26.7	17
8101528	500	1200	350	29.7	17
8101529	560	1290	350	33.2	17
8101530	630	1400	350	37.4	17
8100069	710	1415	400	42.1	17
8100070	800	1550	400	47.4	17
8100071	900	1750	450	53.3	17
8100072	1000	1900	450	59.3	17

End Cap Short Spigot

8139

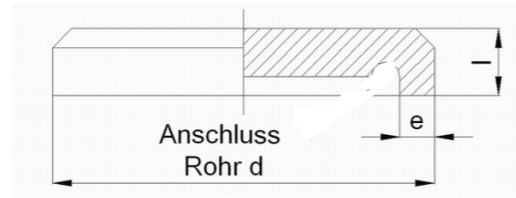

Product Code	d	l	e	SDR
8139001	250	55	22.7	11
8139002	280	60	25.4	11
8139003	315	65	28.6	11
8139004	355	75	32.2	11
8139005	400	80	36.3	11
8139006	450	90	40.9	11
8139007	500	85	45.4	11
8139008	560	100	50.8	11
8139009	630	105	57.2	11
8139010	250	50	14.8	17
8139012	315	60	18.7	17
8139013	355	65	21.1	17
8139014	400	70	23.7	17
8139015	450	80	26.7	17
8139016	500	85	29.7	17
8139017	560	100	33.2	17
8139018	630	100	37.4	17
8139019	710	120	42.1	17
8139020	800	130	47.4	17

Stub Flange Short Spigot

8106

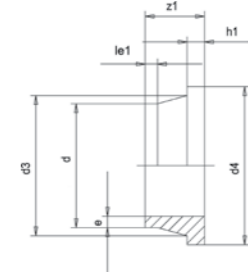

Product Code	d	z1	h1	d3	d4	e	le1	SDR
8106009	20	52	7	27	45	2	30	11
8106010	25	53	9	33	58	2.3	27	11
8106011	32	52	10	40	68	3	28	11
8106012	40	51	11	50	72	3.7	25	11
8106013	50	57	12	61	82	4.6	27	11
8106014	63	60	14	75	94	5.8	25	11
8106015	75	56	16	89	105	6.8	21	11
8106016	90	80	17	105	125	8.2	27	11
8106017	110	80	18	125	158	10	37	11
8106018	125	90	25	132	158	11.4	40	11
8106019	140	83	25	155	188	12.7	35	11
8106020	160	100	25	175	212	14.6	52	11
8106021	180	127	30	186	212	16.4	65	11
8106022	200	140	32	232	268	18.2	65	11
8106023	225	127	32	235	268	20.5	65	11
8106024	250	145	35	285	320	22.7	66	11
8106025	280	155	35	291	320	25.4	80	11
8106026	315	163	35	335	370	28.6	86	11
8106027	355	187	40	373	430	32.2	100	11
8106028	400	195	46	427	482	36.3	95	11
8106029	450	139	60	462	556	40.9	60	11
8106030	500	138	60	530	585	45.4	60	11
8100501	560	195	60	615	665	50.8	70	11
8100502	630	210	60	644	685	57.2	80	11
8100537	710	180	70	737	800	64.5	70	11
8106031	50	57	12	61	82	3	27	17
8106032	63	60	14	75	94	3.8	25	17
8106033	75	56	16	89	105	4.5	21	17
8106034	90	80	17	105	125	5.4	43	17
8106035	110	80	18	125	158	6.6	37	17
8106036	125	87	18	132	158	7.4	45	17
8106037	140	82	18	155	188	8.3	39	17
8106038	160	100	18	175	212	9.5	52	17
8106039	180	127	20	186	212	10.7	75	17
8106040	200	140	24	233	268	11.9	75	17
8106041	225	127	24	235	268	13.4	75	17
8106042	250	140	25	285	320	14.8	71	17
8106043	280	150	25	291	320	16.6	90	17
8106044	315	164	25	335	370	18.7	93	17
8106045	355	180	30	373	430	21.1	100	17
8106046	400	195	33	427	482	23.7	105	17
8106047	450	139	46	462	556	26.7	60	17
8106048	500	138	46	530	585	29.7	60	17
8106049	560	139	50	615	665	33.2	60	17
8106050	630	142	50	642	685	37.4	60	17
8100503	710	160	50	737	800	42.1	65	17
8100504	800	150	54	840	905	47.4	60	17
8100505	900	155	58	944	1005	53.3	50	17
8100506	1000	180	60	1047	1110	59.3	50	17

Concentric Reducer Short Spigot

8149

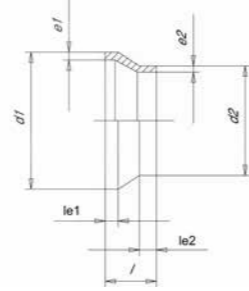

Product Code	d1 x d2	le1	le2	l	e1	e2	SDR
8149001	25 X 20	20	20	68	2.3	2	11
8149002	32 X 20	23	23	68	3	2	11
8149003	32 X 25	25	25	68	3	2.3	11
8149004	40 X 20	18	13	50	3.7	1.9	11
8149005	40 X 25	20	20	62	3.7	2.3	11
8149006	40 X 32	25	25	62	3.7	3	11
8149007	50 X 25	25	25	85	4.6	2.3	11
8149008	50 X 32	20	20	70	4.6	3	11
8149009	50 X 40	25	25	80	4.6	3.7	11
8149010	63 X 32	26	27	89	5.8	3	11
8149011	63 X 40	35	21	89	5.8	3.7	11
8149012	63 X 50	25	25	87	5.8	4.6	11
8149013	75 X 32	25	10	70	6.8	2.9	11
8149016	75 X 40	30	25	70	6.8	3.7	11
8149014	75 X 50	30	28	70	6.8	4.6	11
8149015	75 X 63	25	25	82	6.8	5.8	11
8149017	90 X 50	30	28	93	8.2	4.6	11
8149018	90 X 63	28	28	92	8.2	5.8	11
8149019	90 X 75	30	28	91	8.2	6.8	11
8149020	110 X 50	28	14	90	10	4.6	11
8149021	110 X 63	40	36	105	10	5.8	11
8149022	110 X 75	40	28	96	10	6.8	11
8149023	110 X 90	40	41	104	10	8.2	11
8149024	125 X 63	35	20	97	11.4	5.8	11
8149025	125 X 75	32	19	98	11.4	6.8	11
8149026	125 X 90	42	41	110	11.4	8.2	11
8149027	125 X 110	40	40	100	11.4	10	11
8149028	140 X 75	52	41	135	12.7	6.8	11
8149029	140 X 90	53	42	131	12.7	8.2	11
8149030	140 X 110	50	40	120	12.7	10	11
8149031	140 X 125	51	40	120	12.7	11.4	11
8149032	160 X 90	48	34	141	14.6	8.2	11
8149033	160 X 110	40	34	130	14.6	10	11
8149034	160 X 125	40	32	122	14.6	11.4	11
8149035	160 X 140	49	38	125	14.6	12.7	11
8149036	180 X 90	50	40	145	16.4	8.2	11
8149037	180 X 110	55	42	150	16.4	10	11
8149038	180 X 125	52	40	143	16.4	11.4	11
8149039	180 X 140	51	47	135	16.4	12.7	11
8149040	180 X 160	60	50	140	16.4	14.6	11
8149041	200 X 140	62	42	145	18.2	12.7	11
8149042	200 X 160	63	54	145	18.2	14.6	11
8149043	200 X 180	62	54	145	18.2	16.4	11
8149044	225 X 140	62	49	150	20.5	12.7	11
8149045	225 X 160	65	53	160	20.5	14.6	11
8149046	225 X 180	64	59	160	20.5	16.4	11
8149047	225 X 200	63	53	148	20.5	18.2	11
8149048	250 X 160	65	53	177	22.7	14.6	11
8149049	250 X 180	65	58	175	22.7	16.4	11
8149050	250 X 200	64	64	180	22.7	18.2	11
8149051	250 X 225	65	65	180	22.7	20.5	11
8149052	280 X 200	75	54	214	25.4	18.2	11
8149053	280 X 225	75	58	210	25.4	20.5	11
8149054	280 X 250	75	60	206	25.4	22.7	11
8149055	315 X 200	80	50	225	28.6	18.8	11
8149056	315 X 225	84	57	237	28.6	20.5	11

Concentric Reducer Short Spigot Cont.

8149

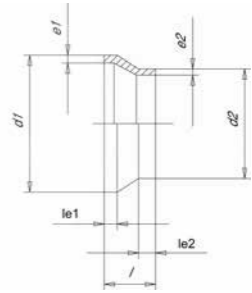

Product Code	d1 x d2	le1	le2	l	e1	e2	SDR
8100081	355 X 225	57	40	140	32.3	20.5	11
8100082	355 X 250	54	40	130	32.3	22.8	11
8100083	355 X 280	53	40	120	32.3	25.5	11
8100084	355 X 315	53	40	110	32.3	28.7	11
8100085	400 X 225	64	40	160	36.4	20.5	11
8100086	400 X 250	61	40	150	36.4	22.8	11
8100087	400 X 280	60	40	140	36.4	25.5	11
8100088	400 X 315	50	40	120	36.4	28.7	11
8100089	400 X 355	51	40	110	36.4	32.3	11
8100090	450 X 280	65	40	160	41	25.5	11
8100091	450 X 315	55	40	140	41	28.7	11
8100092	450 X 355	57	40	130	41	32.3	11
8100093	450 X 400	60	40	120	41	36.4	11
8100094	500 X 315	71	40	170	45.5	28.7	11
8100095	500 X 355	62	40	150	45.5	32.3	11
8100096	500 X 400	65	40	140	45.5	36.4	11
8100097	500 X 450	60	40	120	45.5	41	11
8100098	560 X 400	68	40	160	51	36.4	11
8100099	560 X 450	62	40	140	51	41	11
8100100	560 X 500	67	40	130	51	45.5	11
8100101	630 X 400	78	40	190	57.3	36.4	11
8100102	630 X 450	72	40	170	57.3	41	11
8100103	630 X 500	67	40	150	57.3	45.5	11
8100104	630 X 560	64	40	130	57.3	51	11
8100105	355 X 225	57	40	140	21.1	13.4	17
8100106	355 X 250	54	40	130	21.1	14.8	17
8100107	355 X 280	53	40	120	21.1	16.6	17
8100108	355 X 315	53	40	110	21.1	18.7	17
8100109	400 X 225	64	40	160	23.7	13.4	17
8100110	400 X 250	61	40	150	23.7	14.8	17
8100111	400 X 280	60	40	140	23.7	16.6	17
8100112	400 X 315	50	40	120	23.7	18.7	17
8100113	400 X 355	51	40	110	23.7	21.1	17
8100114	450 X 280	65	40	160	26.7	16.6	17
8100115	450 X 315	55	40	140	26.7	18.7	17
8100116	450 X 355	57	40	130	26.7	21.1	17
8100117	450 X 400	60	40	120	26.7	23.7	17
8100118	500 X 315	71	40	170	29.7	18.7	17
8100119	500 X 355	62	40	150	29.7	21.1	17
8100120	500 X 400	65	40	140	29.7	23.7	17
8100121	500 X 450	60	40	120	29.7	26.7	17
8100122	560 X 400	68	40	160	33.2	23.7	17
8100123	560 X 450	62	40	140	33.2	26.7	17
8100124	560 X 500	67	40	130	33.2	29.7	17
8100125	630 X 400	78	40	190	37.4	23.7	17
8100126	630 X 450	72	40	170	37.4	26.7	17
8100127	630 X 500	67	40	150	37.4	29.7	17
8100128	630 X 560	64	40	130	37.4	33.2	17
8100129	710 X 500	84	40	190	42.1	29.7	17
8100130	710 X 560	81	40	170	42.1	33.2	17
8100131	710 X 630	71	40	140	42.1	37.4	17
8100132	800 X 560	85	40	200	47.4	33.2	17
8100133	800 X 630	85	40	180	47.4	37.4	17
8100134	800 X 710	78	40	150	47.4	42.1	17
8100135	900 X 630	96	40	220	53.3	37.4	17
8100136	900 X 710	89	40	190	53.3	42.1	17

RURAL COMPRESSION
 THREADED FITTINGS
 METRIC COMPRESSION
 TAPPING SADDLES
 VALVES
 ELECTROFUSION
 TOOLING
SIMONA SPIGOTS
 ASSEMBLY INSTRUCTIONS

Concentric Reducer Short Spigot Cont.

8100

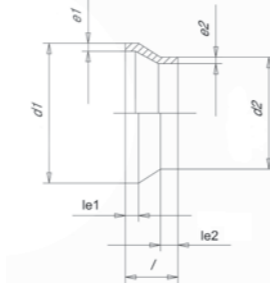

Product Code	d1 x d2	le1	le2	l	e1	e2	SDR
8100137	900 X 800	85	40	160	53.3	47.4	17
8100138	1000 X 710	101	40	230	59.3	42.1	17
8100139	1000 X 800	86	40	190	59.3	47.4	17
8100140	1000 X 900	75	40	150	59.3	53.3	17

Tee Short Spigot

8103

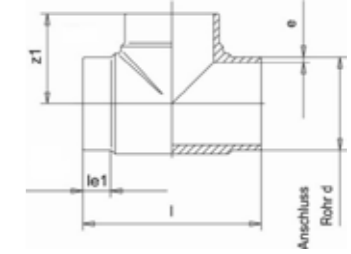

Product Code	d	z1	le1	Length	e	SDR
8103001	20	38	11	76	2	11
8103002	25	40	11	84	2.3	11
8103003	32	42	11	87	3	11
8103004	40	45	11	90	3.7	11
8103005	50	50	12	100	4.6	11
8103006	63	67	17	135	5.8	11
8103007	75	75	19	153	6.8	11
8103008	90	99	43	198	8.2	11
8103009	110	127	55	254	10	11
8103010	125	125	52	254	11.4	11
8103011	140	153	65	314	12.7	11
8103012	160	161	58	322	14.6	11
8103013	180	214	94	430	16.4	11
8103014	200	219	90	438	18.2	11
8103015	225	226	76	452	20.5	11
8103016	250	227	68	450	22.7	11
8103017	280	265	87	530	25.4	11
8103018	315	285	88	570	28.6	11
8103019	355	349	103	698	32.2	11
8103020	400	363	105	730	36.3	11
8103021	450	419	137	837	40.9	11
8103022	500	465	159	930	45.4	11
8103023	50	50	13	100	3	17
8103024	63	67	17	136	3.8	17
8103025	75	75	19	154	4.5	17
8103026	90	99	42	198	5.4	17
8103027	110	129	55	257	6.6	17
8103028	125	125	52	254	7.4	17
8103029	140	157	62	314	8.3	17
8103030	160	160	57	320	9.5	17
8103031	180	214	96	435	10.7	17
8103032	200	220	93	440	11.9	17
8103033	225	225	76	450	13.4	17
8103034	250	225	67	450	14.8	17
8103035	280	264	86	528	16.6	17
8103036	315	282	87	565	18.7	17
8103037	355	348	103	699	21.1	17
8103038	400	361	105	722	23.7	17
8103039	450	419	137	838	26.7	17
8103040	500	471	163	940	29.7	17

Backing Flanges - AS2129 Table D (700 kPa up to 50°C)

PE SIZE	FLANGE SIZE	OD	TCK T _F	PCD	# HOLES	Ø HOLE	BOLT TYPE	GALVANISED		316 SS		GASKET
								FLANGE	BOLT SET - LENGTH (mm)	FLANGE	BOLT SET LENGTH (mm)	
20	DN 15 (1/2")	95	5	67	4	14	M12	8900001	8920001-040 8920001-050 8920001-060	8190001	8930001-040 8930001-050 8930001-060	8940001
25	DN 20 (3/4")	100	5	73	4	14	M12	8900002	8920002-040 8920002-050 8920002-060	8190002	8930002-040 8930002-050 8930002-060	8940002
32	DN25 (1")	115	5	83	4	14	M12	8900003	8920003-040 8920003-050 8920003-060	8190003	8930003-040 8930003-050 8930003-060	8940003
40	DN32 (1-1/4")	120	6	87	4	14	M12	8900004	8920004-040 8920004-050 8920004-060	8190004	8930004-040 8930004-050 8930004-060	8940004
50	DN40 (1-1/2")	135	6	98	4	14	M12	8900005	8920005-040 8920005-050 8920005-060	8190005	8930005-040 8930005-050 8930005-060	8940005
63	DN50 (2")	150	8	114	4	18	M16	8900006	8920006-065 8920006-080 8920006-100	8190006	8930006-065 8930006-080 8930006-100	8940006
75	DN65 (2-1/2")	165	8	127	4	18	M16	8900007	8920007-065 8920007-080 8920007-100	8190007	8930007-065 8930007-080 8930007-100	8940007
90	DN80 (3")	185	10	146	4	18	M16	8900008	8920008-065 8920008-080 8920008-100	8190008	8930008-065 8930008-080 8930008-100	8940008
110	DN100 (4")	215	10	178	4	18	M16	8900009	8920009-065 8920009-080 8920009-100	8190009	8930009-065 8930009-080 8930009-100	8940009
125	DN100 (4")	215	10	178	4	18	M16	8900010	8920010-065 8920010-080 8920010-100	8190010	8930010-065 8930010-080 8930010-100	8940046
125	DN125 (5")	255	13	210	8	18	M16	8900011	8920011-065 8920011-080 8920011-100	8190011	8930011-065 8930011-080 8930011-100	8940010
140	DN125 (5")	255	13	210	8	18	M16	8900012	8920012-065 8920012-080 8920012-100	8190012	8930012-065 8930012-080 8930012-100	8940047
160	DN150 (6")	280	13	235	8	18	M16	8900013	8920013-065 8920013-080 8920013-100	8190013	8930013-065 8930013-080 8930013-100	8940011
180	DN150 (6")	280	13	235	8	18	M16	8900014	8920014-065 8920014-080 8920014-100	8190014	8930014-065 8930014-080 8930014-100	8940048
200	DN200 (8")	335	13	292	8	18	M16	8900015	8920015-065 8920015-080 8920015-100	8190015	8930015-065 8930015-080 8930015-100	8940012
225	DN200 (8")	335	13	292	8	18	M16	8900016	8920016-065 8920016-080 8920016-100	8190016	8930016-065 8930016-080 8930016-100	8940049
250	DN250 (10")	405	16	356	8	22	M20	8900017	8920017-110 8920017-120 8920017-130	8190017	8930017-110 8930017-120 8930017-130	8940013
280	DN250 (10")	405	16	356	8	22	M20	8900018	8920018-110 8920018-120 8920018-130	8190018	8930018-110 8930018-120 8930018-130	8940050
315	DN300 (12")	455	19	406	12	22	M20	8900019	8920019-110 8920019-120 8920019-130	8190019	8930019-110 8930019-120 8930019-130	8940014
355	DN350 (14")	525	22	470	12	26	M24	8900020	8920020-150 8920020-200 8920020-240	8190020	8930020-160 8930020-200 8930020-250	8940015
400	DN400 (16")	580	22	521	12	26	M24	8900021	8920021-150 8920021-200 8920021-240	8190021	8930021-160 8930021-200 8930021-250	8940016
450	DN450 (18")	640	25	584	12	26	M24	8900022	8920021-150 8920021-200 8920021-240	8190022	8930021-160 8930021-200 8930021-250	8940017

Backing Flanges - AS2129 Table D (700 kPa up to 50°C) Cont.

PE SIZE	FLANGE SIZE	OD	TCK T _F	PCD	# HOLES	Ø HOLE	BOLT TYPE	GALVANISED		316 SS		GASKET
								FLANGE	BOLT SET - LENGTH (mm)	FLANGE	BOLT SET LENGTH (mm)	
500	DN500 (20")	705	29	641	16	26	M24	8900023	8920021-150 8920021-200 8920021-240	8190023	8930021-160 8930021-200 8930021-250	8940018
560	DN550 (22")	760	29	699	16	30	M27	8900024	8920024	8190024	8930024	8940019
630	DN600 (24")	825	32	756	16	30	M27	8900025	8920025	8190025	8930025	8940020
710	DN700 (28")	910	35	845	20	30	M27	8900026	8920026	8190026	8930026	8940021
800	DN800 (32")	1060	41	984	20	36	M33	8900027	8920027	8190027	8930027	8940022
900	DN900 (36")	1175	48	1092	24	36	M33	8900028	8920028	8190028	8930028	8940023
1000	DN1000 (40")	1255	51	1175	24	36	M33	8900029	8920029	8190029	8930029	8940024
1200	DN1200 (48")	1490	60	1410	32	36	M33	8900030	8920030	8190030	8930030	8940025

Gasket Material: EPDM
T_G: 3mm

Note: All dimensions in mm unless otherwise noted.
Galvanised bolts are not recommended for use with stainless steel flanges due to potential galvanic corrosion issues.

Backing Flanges - AS2129 Table E (1400 kPa up to 50°C)

PE SIZE	FLANGE SIZE	OD	TCK T _F	PCD	# HOLES	Ø HOLE	BOLT TYPE	GALVANISED		316 SS		GASKET
								FLANGE	BOLT SET - LENGTH (mm)	FLANGE	BOLT SET LENGTH (mm)	
20	DN 15 (1/2")	95	6	67	4	14	M12	8900031	8920031-040 8920031-050 8920031-060	8910031	8930031-040 8930031-050 8930031-060	8940001
25	DN 20 (3/4")	100	6	73	4	14	M12	8900032	8920032-040 8920032-050 8920032-060	8910032	8930032-040 8930032-050 8930032-060	8940002
32	DN25 (1")	115	7	83	4	14	M12	8900033	8920033-040 8920033-050 8920033-060	8910033	8930033-040 8930033-050 8930033-060	8940003
40	DN32 (1-1/4")	120	8	87	4	14	M12	8900034	8920034-040 8920034-050 8920034-060	8910034	8930034-040 8930034-050 8930034-060	8940004
50	DN40 (1-1/2")	135	9	98	4	14	M12	8900035	8920035-040 8920035-050 8920035-060	8910035	8930035-040 8930035-050 8930035-060	8940005
63	DN50 (2")	150	10	114	4	18	M16	8900036	8920036-065 8920036-080 8920036-100	8910036	8930036-065 8930036-080 8930036-100	8940006
75	DN65 (2-1/2")	165	10	127	4	18	M16	8900037	8920037-065 8920037-080 8920037-100	8910037	8930037-065 8930037-080 8930037-100	8940007
90	DN80 (3")	185	11	146	4	18	M16	8900038	8920038-065 8920038-080 8920038-100	8910038	8930038-065 8930038-080 8930038-100	8940008
110	DN100 (4")	215	13	178	8	18	M16	8900039	8920039-065 8920039-080 8920039-100	8910039	8930039-065 8930039-080 8930039-100	8940026
125	DN100 (4")	215	13	178	8	18	M16	8900040	8920040-065 8920040-080 8920040-100	8910040	8930040-065 8930040-080 8930040-100	8940051
125	DN125 (5")	255	14	210	8	18	M16	8900041	8920041-065 8920041-080 8920041-100	8910041	8930041-065 8930041-080 8930041-100	8940010
140	DN125 (5")	255	14	210	8	18	M16	8900042	8920042-065 8920042-080 8920042-100	8910042	8930042-065 8930042-080 8930042-100	8940047
160	DN150 (6")	280	17	235	8	22	M20	8900043	8920043-110 8920043-120 8920043-130	8910043	8930043-110 8930043-120 8930043-130	8940011
180	DN150 (6")	280	17	235	8	22	M20	8900044	8920044-110 8920044-120 8920044-130	8910044	8930044-110 8930044-120 8930044-130	8940048
200	DN200 (8")	335	19	292	8	22	M20	8900045	8920045-110 8920045-120 8920045-130	8910045	8930045-110 8930045-120 8930045-130	8940012
225	DN200 (8")	335	19	292	8	22	M20	8900046	8920046-110 8920046-120 8920046-130	8910046	8930046-110 8930046-120 8930046-130	8940049
250	DN250 (10")	405	22	356	12	22	M20	8900047	8920047-110 8920047-120 8920047-130	8910047	8930047-110 8930047-120 8930047-130	8940027
280	DN250 (10")	405	22	356	12	22	M20	8900048	8920048-110 8920048-120 8920048-130	8910048	8930048-110 8930048-120 8930048-130	8940052
315	DN300 (12")	455	25	406	12	26	M24	8900049	8920049-150 8920049-200 8920049-240	8910049	8930049-160 8930049-200 8930049-250	8940014
355	DN350 (14")	525	29	470	12	26	M24	8900050	8920050-150 8920050-200 8920050-240	8910050	8930050-160 8930050-200 8930050-250	8940015

Backing Flanges - AS2129 Table E (1400 kPa up to 50°C) Cont.

PE SIZE	FLANGE SIZE	OD	TCK T _F	PCD	# HOLES	Ø HOLE	BOLT TYPE	GALVANISED		316 SS		GASKET
								FLANGE	BOLT SET - LENGTH (mm)	FLANGE	BOLT SET LENGTH (mm)	
400	DN400 (16")	580	32	521	12	26	M24	8900051	8920051-150 8920051-200 8920051-240	8910051	8930051-160 8930051-200 8930051-250	8940016
450	DN450 (18")	640	35	584	16	26	M24	8900052	8920052-150 8920052-200 8920052-240	8910052	8930052-160 8930052-200 8930052-250	8940028
500	DN500 (20")	705	38	641	16	26	M24	8900053	8920053-150 8920053-200 8920053-240	8910053	8930053-160 8930053-200 8930053-250	8940018
560	DN550 (22")	760	44	699	16	30	M27	8900054	8920054	8910054	8930054	8940019
630	DN600 (24")	825	48	756	16	33	M30	8900055	8920055	8910055	8930055	8940020
710	DN700 (28")	910	51	845	20	33	M30	8900056	8920056	8910056	8930056	8940021
800	DN800 (32")	1060	54	984	20	36	M33	8900057	8920057	8910057	8930057	8940022
900	DN900 (36")	1175	64	1092	24	36	M33	8900058	8920058	8910058	8930058	8940023
1000	DN1000 (40")	1255	67	1175	24	39	M36	8900059	8920059	8910059	8930059	8940024
1200	DN1200 (48")	1490	79	1410	32	39	M36	8900060	8920060	8910060	8930060	8940025

Gasket Material: EPDM
T_G: 3mm

Note: All dimensions in mm unless otherwise noted.
Galvanised bolts are not recommended for use with stainless steel flanges due to potential galvanic corrosion issues.

Backing Flanges - AS4087 PN16 (up to 80°C)

PE SIZE	FLANGE SIZE	OD	TCK T _F	PCD	# HOLES	Ø HOLE	BOLT TYPE	GALVANISED		316 SS		GASKET
								FLANGE	BOLT SET - LENGTH (mm)	FLANGE	BOLT SET LENGTH (mm)	
63	DN50 (2")	150	11	114	4	18	M16	8900036	8920036-065 8920036-080 8920036-100	8910036	8930036-065 8930036-080 8930036-100	8940006
75	DN65 (2-1/2")	165	11	127	4	18	M16	8900037	8920037-065 8920037-080 8920037-100	8910037	8930037-065 8930037-080 8930037-100	8940007
90	DN80 (3")	185	11	146	4	18	M16	8900061	8920061-065 8920061-080 8920061-100	8910061	8930061-065 8930061-080 8930061-100	8940008
110	DN100 (4")	215	13	178	4	18	M16	8900062	8920062-065 8920062-080 8920062-100	8910062	8930062-065 8930062-080 8930062-100	8940009
125	DN100 (4")	215	13	178	4	18	M16	8900063	8920063-065 8920063-080 8920063-100	8910063	8930063-065 8930063-080 8930063-100	8940046
160	DN150 (6")	280	13	235	8	18	M16	8900013	8920013-065 8920013-080 8920013-100	8910013	8930013-065 8930013-080 8930013-100	8940011
180	DN150 (6")	280	13	235	8	18	M16	8900014	8920014-065 8920014-080 8920014-100	8910014	8930014-065 8930014-080 8930014-100	8940048
200	DN200 (8")	335	19	292	8	18	M16	8900064	8920064-065 8920064-080 8920064-100	8910064	8930064-065 8930064-080 8930064-100	8940012
225	DN200 (8")	335	19	292	8	18	M16	8900065	8920065-065 8920065-080 8920065-100	8910065	8930065-065 8930065-080 8930065-100	8940049
250	DN250 (10")	405	19	356	8	22	M20	8900066	8920066-110 8920066-120 8920066-130	8910066	8930066-110 8930066-120 8930066-130	8940013
280	DN250 (10")	405	19	356	8	22	M20	8900067	8920067-110 8920067-120 8920067-130	8910067	8930067-110 8930067-120 8930067-130	8940050
315	DN300 (12")	455	23	406	12	22	M20	8900068	8920068-110 8920068-120 8920068-130	8910068	8930068-110 8930068-120 8930068-130	8940014
355	DN350 (14")	525	30	470	12	26	M24	8900050	8920050-150 8920050-200 8920050-240	8910050	8930050-160 8930050-200 8930050-250	8940015
400	DN400 (16")	580	30	521	12	26	M24	8900069	8920069-150 8920069-200 8920069-240	8910069	8930069-160 8930069-200 8930069-250	8940016
450	DN450 (18")	640	30	584	12	26	M24	8900070	8920070-150 8920070-200 8920070-240	8910070	8930070-160 8930070-200 8930070-250	8940017
500	DN500 (20")	705	38	641	16	26	M24	8900053	8920053-150 8920053-200 8920053-240	8910053	8930053-160 8930053-200 8930053-250	8940018
630	DN600 (24")	825	48	756	16	30	M27	8900071	8920071	8910071	8930071	8940020
710	DN700 (28")	910	56	845	20	30	M27	8900072	8920072	8910072	8930072	8940021
800	DN800 (32")	1060	56	984	20	36	M33	8900073	8920073	8910073	8930073	8940022
900	DN900 (36")	1175	66	1092	24	36	M33	8900074	8920074	8910074	8930074	8940023
1000	DN1000 (40")	1255	66	1175	24	36	M33	8900075	8920075	8910075	8930075	8940024
1200	DN1200 (48")	1490	76	1410	32	36	M33	8900076	8920076	8910076	8930076	8940025

Gasket Material: Fibre
T_G: 1.5mm

Note: All dimensions in mm unless otherwise noted.
Galvanised bolts are not recommended for use with stainless steel flanges due to potential galvanic corrosion issues.

Backing Flanges - AS4087 PN21 (up to 80°C)

PE SIZE	FLANGE SIZE	OD	TCK T _F	PCD	# HOLES	Ø HOLE	BOLT TYPE	GALVANISED		316 SS		GASKET
								FLANGE	BOLT SET - LENGTH (mm)	FLANGE	BOLT SET LENGTH (mm)	
63	DN50 (2")	165	15	127	4	18	M16	8900077	8920077-065 8920077-080 8920077-100	8910077	8930077-065 8930077-080 8930077-100	8950001
75	DN65 (2-1/2")	185	15	146	8	18	M16	8900078	8920078-065 8920078-080 8920078-100	8910078	8930078-065 8930078-080 8930078-100	8950002
90	DN80 (3")	205	15	165	8	18	M16	8900079	8920079-065 8920079-080 8920079-100	8910079	8930079-065 8930079-080 8930079-100	8950003
110	DN100 (4")	230	19	191	8	18	M16	8900080	8920080-065 8920080-080 8920080-100	8910080	8930080-065 8930080-080 8930080-100	8950004
125	DN100 (4")	230	19	191	8	18	M16	8900081	8920081-065 8920081-080 8920081-100	8910081	8930081-065 8930081-080 8930081-100	8950020
160	DN150 (6")	305	24	260	12	22	M20	8900082	8920082-110 8920082-120 8920082-130	8910082	8930082-110 8930082-120 8930082-130	8950006
180	DN150 (6")	305	24	260	12	22	M20	8900083	8920083-110 8920083-120 8920083-130	8910083	8930083-110 8930083-120 8930083-130	8950021
200	DN200 (8")	370	24	324	12	22	M20	8900084	8920084-110 8920084-120 8920084-130	8910084	8930084-110 8930084-120 8930084-130	8950007
225	DN200 (8")	370	24	324	12	22	M20	8900085	8920085-110 8920085-120 8920085-130	8910085	8930085-110 8930085-120 8930085-130	8950022
250	DN250 (10")	430	30	381	12	26	M24	8900086	8920086-150 8920086-200 8920086-240	8910086	8930086-160 8930086-200 8930086-250	8950008
280	DN250 (10")	430	30	381	12	26	M24	8900087	8920086-150 8920086-200 8920086-240	8910087	8930087-160 8930087-200 8930087-250	8950023
315	DN300 (12")	490	30	438	16	26	M24	8900088	8920088-150 8920088-200 8920088-240	8910088	8930088-160 8930088-200 8930088-250	8950009
355	DN350 (14")	550	30	495	16	30	M27	8900089	8920089	8910089	8930089	8950010
400	DN400 (16")	610	38	552	20	30	M27	8900090	8920090	8910090	8930090	8950011
450	DN450 (18")	675	38	610	20	33	M30	8900091	8920091	8910091	8930091	8950012
500	DN500 (20")	735	48	673	24	33	M30	8900092	8920092	8910092	8930092	8950013
630	DN600 (24")	850	58	781	24	36	M33	8900093	8920093	8910093	8930093	8950014
710	DN700 (28")	935	58	857	24	36	M33	8900094	8920094	8910094	8930094	8950015
800	DN800 (32")	1060	58	984	28	36	M33	8900095	8920095	8910095	8930095	8950016
900	DN900 (36")	1185	68	1105	32	39	M36	8900096	8920096	8910096	8930096	8950017
1000	DN1000 (40")	1275	78	1194	36	39	M36	8900097	8920097	8910097	8930097	8950018
1200	DN1200 (48")	1530	88	1441	40	42	M39	8900098	8920098	8910098	8930098	8950019

Gasket Material: Fibre
T_G: 1.5mm

Note: All dimensions in mm unless otherwise noted.
Galvanised bolts are not recommended for use with stainless steel flanges due to potential galvanic corrosion issues.

Backing Flanges - AS4087 PN35 (up to 80°C)

PE SIZE	FLANGE SIZE	OD	TCK T _F	PCD	# HOLES	Ø HOLE	BOLT TYPE	GALVANISED		316 SS		GASKET
								FLANGE	BOLT SET - LENGTH (mm)	FLANGE	BOLT SET LENGTH (mm)	
63	DN50 (2")	165	19	127	4	18	M16	8900099	8920099-110	8910099	8930099-110	8950001
75	DN65 (2-1/2")	185	19	146	8	18	M16	8900100	8920100-110	8910100	8930100-110	8950002
90	DN80 (3")	205	24	165	8	18	M16	8900101	8920101-110	8910101	8930101-110	8950003
110	DN100 (4")	230	24	191	8	18	M16	8900102	8920102-110	8910102	8930102-110	8950004
125	DN100 (4")	230	24	191	8	18	M16	8900103	8920103-110	8910103	8930103-110	8950020
160	DN150 (6")	305	31	260	12	22	M20	8900104	8920104-130	8910104	8930104-130	8950006
180	DN150 (6")	305	31	260	12	22	M20	8900105	8920105-130	8910105	8930105-130	8950021
200	DN200 (8")	370	31	324	12	22	M20	8900106	8920106-130	8910106	8930106-130	8950007
225	DN200 (8")	370	31	324	12	22	M20	8900107	8920107-130	8910107	8930107-130	8950022
250	DN250 (10")	430	38	381	12	26	M24	8900108	8920108-150	8910108	8930108-150	8950008
280	DN250 (10")	430	38	381	12	26	M24	8900109	8920109-150	8910109	8930109-150	8950023
315	DN300 (12")	490	38	438	16	26	M24	8900110	8920110-150	8910110	8930110-150	8950009
355	DN350 (14")	550	48	495	16	30	M27	8900111	8920111-170	8910111	8930111-170	8950010
400	DN400 (16")	610	48	552	20	30	M27	8900112	8920112-170	8910112	8930112-170	8950011
450	DN450 (18")	675	58	610	20	33	M30	8900113	8920113-190	8910113	8930113-190	8950012
500	DN500 (20")	735	58	673	24	33	M30	8900114	8920114-190	8910114	8930114-190	8950013
630	DN600 (24")	850	68	781	24	36	M33	8900115	8920115-210	8910115	8930115-210	8950014
710	DN700 (28")	935	78	857	24	36	M33	8900116	8920116-210	8910116	8930116-210	8950015
800	DN800 (32")	1060	84	984	28	36	M33	8900117	8920117-210	8910117	8930117-210	8950016
900	DN900 (36")	1185	94	1105	32	39	M36	8900118	8920118	8910118	8930118	8950017
1000	DN1000 (40")	1275	98	1194	36	39	M36	8900119	8920119	8910119	8930119	8950018
1200	DN1200 (48")	1530	108	1441	40	42	M39	8900120	8920120	8910120	8930120	8950019

Gasket Material: Fibre
T_G: 1.5mm

Note: All dimensions in mm unless otherwise noted.
Galvanised bolts are not recommended for use with stainless steel flanges due to potential galvanic corrosion issues.

Backing Flanges - ASME B16.5 ANSI 150#

PE SIZE	FLANGE SIZE	OD	TCK T _F	PCD	# HOLES	Ø HOLE	BOLT TYPE	A105 GALVANISED		316 SS		GASKET
								FLANGE	BOLT SET - LENGTH (mm)	FLANGE	BOLT SET LENGTH (mm)	
20	DN15 (1/2")	88.9	9.7	60.5	4	15.9	1/2"	8900121	8920121-40 8920121-50 8920121-60	8910121	8930121-40 8930121-50 8930121-60	8940029
25	DN20 (3/4")	98.6	11.2	69.9	4	15.9	1/2"	8900122	8920122-40 8920122-50 8920122-60	8910122	8930122-40 8930122-50 8930122-60	8940030
32	DN25 (1")	108	12.7	79.2	4	15.9	1/2"	8900123	8920123-40 8920123-50 8920123-60	8910123	8930123-40 8930123-50 8930123-60	8940031
40	DN32 (1-1/4")	117.3	14.2	88.9	4	15.9	1/2"	8900124	8920124-40 8920124-50 8920124-60	8910124	8930124-40 8930124-50 8930124-60	8940032
50	DN40 (1-1/2")	127	15.7	98.6	4	15.9	1/2"	8900125	8920125-40 8920125-50 8920125-60	8910125	8930125-40 8930125-50 8930125-60	8940033
63	DN50 (2")	152.4	17.5	120.7	4	19.1	5/8"	8900126	8920126-65 8920126-80 8920126-100	8910126	8930126-65 8930126-80 8930126-100	8940034
75	DN65 (2-1/2")	177.8	20.6	139.7	4	19.1	5/8"	8900127	8920127-65 8920127-80 8920127-100	8910127	8930127-65 8930127-80 8930127-100	8940035
90	DN80 (3")	190.5	22.4	152.4	4	19.1	5/8"	8900128	8920128-65 8920128-80 8920128-100	8910128	8930128-65 8930128-80 8930128-100	8940036
110	DN100 (4")	228.6	22.4	190.5	8	19.1	5/8"	8900129	8920129-110	8910129	8930129-110	8940037
125	DN100 (4")	228.6	22.4	190.5	8	19.1	5/8"	8900130	8920130-110	8910130	8930130-110	8940053
125	DN125 (5")	254.0	22.4	215.9	8	22.2	3/4"	8900131	8920131-130	8910131	8930131-130	8940038
140	DN125 (5")	254.0	22.4	215.9	8	22.2	3/4"	8900132	8920132-130	8910132	8930132-130	8940054
160	DN150 (6")	279.4	23.9	241.3	8	22.2	3/4"	8900133	8920133-130	8910133	8930133-130	8940039
180	DN150 (6")	279.4	23.9	241.3	8	22.2	3/4"	8900134	8920134-130	8910134	8930134-130	8940055
200	DN200 (8")	342.9	26.9	298.5	8	22.2	3/4"	8900135	8920135-130	8910135	8930135-130	8940040
225	DN200 (8")	342.9	26.9	298.5	8	22.2	3/4"	8900136	8920136-130	8910136	8930136-130	8940056
250	DN250 (10")	406.4	28.4	362.0	12	25.4	7/8"	8900137	8920137-150	8910137	8930137-150	8940041
280	DN250 (10")	406.4	28.4	362.0	12	25.4	7/8"	8900138	8920138-150	8910138	8930138-150	8940057
315	DN300 (12")	482.6	30.2	431.8	12	25.4	7/8"	8900139	8920139-150	8910139	8930139-150	8940042
355	DN350 (14")	533.4	33.3	476.3	12	28.6	1"	8900140	8920140-170	8910140	8930140-170	8940043
400	DN400 (16")	596.9	35.1	539.8	16	28.6	1"	8900141	8920141-170	8910141	8930141-170	8940044
450	DN450 (18")	635.0	38.1	577.9	16	31.8	1.1/8"	8900142	8920142-190	8910142	8930142-190	8940045

*Plasson offers
M12 for 1/2"
M16 for 5/8"
M20 for 3/4"
M24 for 7/8"
M27 for 1"
M30 for 1.1/8"
Please check suitability for your system.

Gasket Material: EPDM
T_G: 3mm

Note: All dimensions in mm unless otherwise noted.
Galvanised bolts are not recommended for use with stainless steel flanges due to potential galvanic corrosion issues.



PLASSON

INSTALLATION AND SPECIFICATIONS

Technical Specifications

Compression Fittings

Body: Polypropylene, high-grade copolymer.
Nut: Polypropylene, high-grade copolymer.
Grip Ring: Acetal POM (CPVC also available).
Seal: NBR or EPDM (FPM also available).
Reinforcing Ring: Stainless steel on all female offtakes from 1¼" up to 4".
Bolts (160mm fittings): Plated steel.
Nuts (160mm fittings): Stainless steel.
Flange dimensions in accordance with: ISO 7005-1 (TABLE 11), BS 4504: 1989 (TABLE 11), DIN 2501 (PN 16 TABLE), AS/NZS 4331. Metal backing rings to be used with all flanges.
Note: Galvanised via electroplating then protected with a proprietary passivation process.

Valves

Valves - PP (340 / 304)

Body: Polypropylene high grade copolymer.
O-Ring: NBR unless otherwise noted in product description.
Spring: (Items 03067, 03039) Stainless Steel.

Valves - PVC (1114 / 1115 / 1135)

Injection-moulded components: PVC-U.
O-Rings: EPDM.
Springs: Stainless steel 316.
Gaskets (on ball): PTFE (polytetrafluoroethylene).

Valves – Polymaide (3703)

Body & Spindle: Glass Reinforced Polyamide
Ball: Glass Reinforced Polypropylene.
Ball Seat: Polyethylene.
Handle: Polypropylene.
Seals: EPDM.

Saddles

Mechanical:

Body: Polypropylene, high-grade copolymer.
Bolts and Nuts: Varies.
Reinforcing Rings: Stainless steel.
Seal: Nitrile rubber (NBR / EPDM).

Plassaddle:

Main Nut: Glass Reinforced Polyamide.
Clamp Arms: Glass Reinforced Polypropylene.
Pressurised Body: Polypropylene PPB.
Seal: EPDM.

Tapper Components:

Body and Compression nut: Polypropylene, high grade copolymer.
Grip Ring: Acetal (POM).
Seal: NBR .
Cutter: DZR Brass.

Threaded Fittings

Body: Polypropylene, high-grade copolymer.
Reinforcing Ring: Stainless Steel.

Operating Temperatures

Refer to the PIPA POP013 guidelines.
Link: <https://pipa.com.au>

Chemical Resistance

PLASSON Fittings are supplied, as standard, with polyacetal split rings and NBR O-rings which are suitable for water. For aggressive chemical applications CPVC split rings and EPDM or FPM O-rings can be supplied to produce a higher chemical resistance.

Quality Certificates

Plasson fittings are tested and approved according to ISO 17885 (replaced ISO 14236), water and AS/NZ 4129.

Threads

All threads conform to ISO-7/1 (BSPT), BS 21 - 1973, DIN 2999, NEN 3258, AS 1722 Part 1 - 1975.

All internal (female) threads smaller than 3" are parallel (Rp). All other threads (male and female) are tapered (R). Plasson recommend the use of PTFE tape in threaded connections.

Installation

Before installation ensure that the end of the pipe to be inserted into the fitting is free of scratches and other imperfections and that both the pipe and the fitting itself are clean of sand, mud, stones etc.

Do not over tighten nut when closing. Never use wrenches or spanners with handle lengths longer than 46 cm - excessive torque during tightening can spread nut cone and result in pull outs. If fittings are reused, Plasson recommend replacing the grip ring with a new one.

Electrofusion

Plasson Electrofusion fittings are globally recognized as best in class. Most fittings include SmartFuse resistors built into the welding terminal, this enables automatic weld time recognition when used with a Plasson electrofusion machine.

Polyethylene: PE 100 RC.

Brass components: DZR Brass.

Stainless Steel components: SS316.

Electrofusion fittings: Are batch controlled, record the batch number on the fitting label and contact Plasson Australia for a copy of the material datasheet / EN 10204 3.1 Inspection Certificate.

Installation:

Plasson Australia no longer publish generic how to perform electrofusion instructions. Plasson Australia recommend installation as per POP001 - Electrofusion Jointing of PE Pipe and Fittings for Pressure Applications as published by Plastics Industry Pipe Association of Australia (PIPA). This is free to download from <https://pipa.com.au>

Some products are unique to Plasson and require specialised tools or installation instructions, these products come with printed instructions included in the fitting bag.

Simona Spigot fittings

Polyethylene: PE 100 RC.

Simona spigot fittings are batch controlled, record the batch number on the fitting label and visit <https://certificates.plasson.com.au/> for a copy of the material datasheet / EN 10204 3.1 Inspection Certificate.

Backing Flanges

Galvanised flanges are hot dipped galvanised. Stainless Steel are SS316L. Galvanized ANSI flanges are A105 grade. Plasson flanges are heat traced. Record the product code and heat code clearly marked on the flange and contact Plasson Australia for a copy of the heat certificate.

Compressed Air Applications

The following are the recommendations for Plasson fittings in compressed air systems with estimated design life of 50 years.

FITTING	SIZE	BAR	BAR	BAR
COMPRESSION FITTINGS	16-125mm (PN16 Water)	12.5	11.3	10.1
THREADED FITTINGS	1/2" to 2" (PN16 Water)	7.8	7	6.3
THREADED BUSHES	1/2" to 1"	7.8	7	6.3
THREADED CAPS	1.1/4" to 2"	4.8	4.4	3.9
TAPPING SADDLES - MECHANICAL	20 - 160mm (Includes Threaded Outlets)	5	4.4	3.9
ELECTROFUSION FITTINGS	20 - 400mm (PN16 Water)	7.8	7.0	6.3
	63 - 400mm Lightfit (PN10 Water)	12.5	11.3	10.1
		7.8	7.0	6.3

Legend	
Bag	Units par bag
Carton	Units per carton
W	Weight in grams

METRIC COMPRESSION 16MM - 63MM



1



CUT PIPE SQUARE, CHAMFER END OF PIPE AND APPLY SILICON-BASED LUBRICANT TO MAKE INSTALL EASIER AND AVOID POTENTIAL DAMAGE TO THE CAPTIVE O-RINGS

2

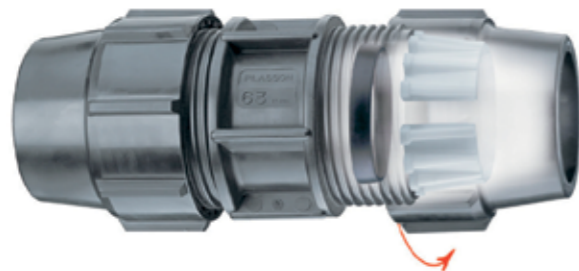

BACK THE NUTS OFF SEVERAL TURNS BUT DO NOT REMOVE THE NUT FROM THE FITTING BODY

3

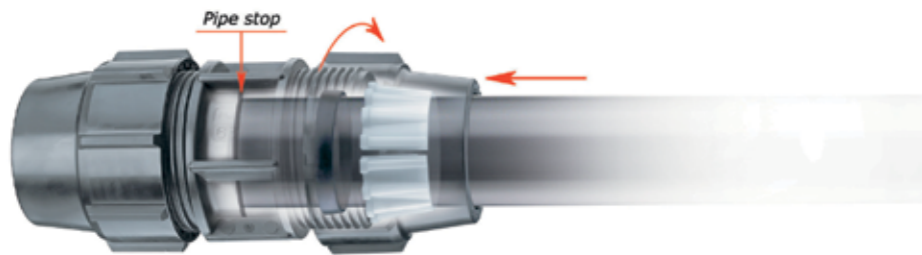

INSERT PIPE INTO FITTING WITH A TWISTING MOTION PAST THE GRIP RING AND O-RING UNTIL IT HITS THE END STOP

4



FOR 16-32MM HAND-TIGHTEN AND FOR 40-63MM HAND-TIGHTEN AND USE WRENCHES TO DO UP A FURTHER HALF TURN

METRIC COMPRESSION 63MM MINE 75MM - 125MM



1



REMOVE NUT AND PUT GRIP RING ASIDE

PLACE NUT, BUSH AND O-RING ON PIPE TWO DIAMETERS BACK FROM END

LUBRICATE PIPE AND O-RING

2



PUSH THE PIPE FULLY ONTO FITTING BODY UP TO END STOP

PUSH THE O-RING AND BUSH UP AGAINST FITTING BODY

NOTE: THE O-RING AND BUSH WILL NOT ENTER THE FITTING BODY

3



TIGHTEN NUT TO PUSH BUSH AND O-RING INTO FITTING UNTIL BUSH IS FLUSH WITH FITTING MOUTH

NOTE: THE GRIP RING IS STILL NOT INSTALLED AT THIS POINT

4



UNDO NUT AND SLIDE BACK ALONG PIPE

INSTALL GRIP RING TO LUGS ARE TOUCHING BUSH

NOTE: IF REINSTALLING FITTINGS DESTROY OLD GRIP RINGS AND REPLACE WITH NEW ONES TO ENSURE FIRM BITE

5



FIRMLY HAND-TIGHTEN PLUS A 1/2 TURN WITH WRENCHES
MAXIMUM HANDLE LENGTH: 45CM

NOTE: OVER-TIGHTENING NUTS CAN CAUSE BLOWOUTS

RURAL COMPRESSION

1/2" - 2"

1



PLACE NUTS AND GRIP RINGS ON PIPE ENDS

2



PUSH RED BARBED INSERT INTO PIPE & FITTING

3



SLIDE NUTS & GRIP RINGS UP TO FITTING BODY

4



DO BOTH NUTS UP BY HAND UNTIL FIRMLY TIGHT

NOTE: USING WRENCHES MAY LEAD TO OVER-TIGHTENING WHICH CAN RESULT IN BLOW OUTS

Reference Guides and Charts

Standard Dimension Ratios (SDR's) For Series 1 Pe Pipes And Equivalent Pressure Rating In Bar

Compound	PN3.2	PN4	PN6.3	PN8	PN10	PN12.5	PN16	PN20	PN25
PE80	41	33	21	17	13.6	11	9	7.4	-
PE100	-	41	26	21	17	13.6	11	9	7.4

Standard Pipe Colour Chart

Colour	Common Use
Blue	Water
Orange	Electrical Conduit
Yellow	Gas - PE100
Red	Fire Service Water
Green	Imperial Rural / Raw Water
Purple	Recycled / Reclaimed Water
Cream	Sewer

Maximum Allowable Operating Pressure – PE100 (Ref PIPA POP013)

Temp (°C)	Min Life (YR)	Design Factor	PN4 / SDR41	PN6.3 / SDR26	PN8 / SDR21	PN10 / SDR17	PN12.5 / SDR13.6	PN16 / SDR11	PN20 / SDR9	PN25 / SDR7.4
20	100	1.0	40	64	80	100	127	160	200	250
25	100	1.1	36	58	73	91	115	145	182	227
30	100	1.1	36	58	73	91	115	145	182	227
35	50	1.2	33	53	67	83	106	133	167	208
40	50	1.2	33	53	67	83	106	133	167	208
45	35	1.3	31	49	62	77	99	123	154	192
50	22	1.4	29	46	57	71	91	114	143	179
55	15	1.4	29	46	57	71	91	114	143	179
60	7	1.5	27	43	53	67	85	107	133	167
80	1	2.0	20	32	40	50	63	80	100	125

Information correct when printed. To ensure you are using the most up to date data for the Industry Guidelines POP013 visit the PIPA Website <https://pipa.com.au/technical/pop-guidelines>

Rural Poly Pipe (Class B) | Imperial Type Class C&D (ASK119)

Size Nominal	Rural (B)		Class C 900 kPa (130 PSI) No Longer Manufactured		Class D 1200 kPa (173 PSI) No Longer Manufactured	
	BORE MM	WALL THICKNESS MM	BORE MM	WALL THICKNESS MM	BORE MM	WALL THICKNESS MM
1/2"	12.7	1.7	12.7	1.7	12.7	1.8
3/4"	19.0	1.7	19.0	1.9	19.0	2.7
1"	25.4	1.7	25.4	2.6	25.4	3.5
1 1/4"	31.6	2.1	31.6	3.3	31.6	4.4
1"	38.0	2.5	38.0	3.9	38.0	5.3
2"	50.8	3.4	50.8	5.2	50.8	7.1

Dimensions are mean sizes only.



PLASSON

TERMS AND CONDITIONS

Terms and Conditions

1. DEFINITIONS & INTERPRETATION

"Agreement" means the agreement for supply of Goods between PLASSON and the Customer of which these "Conditions of Sale" form part.

"Business Day" means a day other than a Saturday, Sunday, public holiday or bank holiday in Sydney, New South Wales.

"Charges" includes all monies payable by the Customer to PLASSON in relation to the supply of Goods. "Confirmation of Order" means a written document which sets out a description of the Goods, the Charges and other necessary terms and which may include details of the Customer's offer to purchase the Goods.

"Customer" means the entity which orders Goods from PLASSON or to which Goods are delivered by PLASSON and includes the Customer's agents and permitted assigns.

"Ex Works" has the same meaning as is ascribed to that term in Incoterms 1990.

"Goods" means the goods purchased or ordered by the Customer from Plasson and includes parts and supplies which may subsequently be supplied under any warranty given in relation the Goods.

"GST" means goods and services tax imposed in Australia by the GST law.

"PLASSON" means PLASSON Australia Pty Ltd ACN 053 788 891, its agents and assigns.

"Permitted Security Interest" means any security interest which PLASSON consents to or otherwise agrees in writing with the Customer will be a Permitted Security Interest for the purposes of these terms and conditions.

"Persons" includes corporations, partnerships and unincorporated associations.

"PPSA" means the Personal Property Securities Act 2009 (Cth) as amended. "PPSR" means the Personal Property Security Register. "Purchase Money Security Interest" has the meaning prescribed to it in the PPSA. "Security Interest" has the meaning prescribed to it in the PPSA and includes any security interest under the PPS Act.

Words importing the singular number shall include the plural and vice versa.

2. CONDITIONS

These Conditions of Sale apply to all agreements for the supply of Goods by PLASSON and if revised by PLASSON and the Customer is notified of the revised Conditions of Sale the revised Conditions of Sale shall be incorporated into every subsequent agreement for purchase of Goods by that Customer from PLASSON.

3. QUOTATIONS AND ENTRY INTO AGREEMENT

3.1. No brochure, catalogue, price list, quotation or other communication published or forwarded by PLASSON to the Customer, whether in writing or not, shall constitute anything other than an invitation by PLASSON to the Customer to do business and shall not represent that the Goods or Charges referred to in them shall be available to the Customer. Any purchase order placed by the Customer with PLASSON constitutes only an offer to purchase Goods.

Notwithstanding any prior communication between PLASSON and the Customer, there shall be no obligation by PLASSON to accept an offer to purchase Goods made by a Customer. The Customer's offer is only accepted by PLASSON issuing a Confirmation of Order to the Customer.

3.2. In the event of any inconsistency between the Customer's purchase order or other request and PLASSON's Confirmation of Order (which includes these Conditions), the terms of the Confirmation of Order shall prevail.

3.3. Unless otherwise stated in the Confirmation of Order prices quoted are exclusive of GST and the Customer is required to pay any GST payable by PLASSON in respect to the supply of Goods at the same time as the price is required to be paid by the Customer to PLASSON.

4. FUNCTIONALITY AND PERFORMANCE

4.1. All information, specifications or other data provided by PLASSON in relation to the Goods represent approximations only and small deviations or slight variations from them which do not substantially diminish the functionality or performance of the Goods will not entitle the Customer to reject the Goods.

4.2. Information provided by PLASSON in relation to the performance of Goods represents only a guide as to the performance of the Goods under optimum operating conditions.

4.3. Without limiting the operation of Clause 4.2, PLASSON may at its sole discretion provide the Customer with training manuals and other materials in relation to the Goods. PLASSON gives no representation or warranty as to the accuracy of such materials or the use of them by the Customer.

5. CHARGES

5.1. The Customer shall pay to PLASSON all Charges within thirty (30) days from the date of the Invoice without reduction or deferment on account of any claim, counterclaim or setoff.

5.2. The Customer acknowledges that the cost of transportation and freight for the Goods is not included in the Charges and the Customer shall pay a reasonable additional fee for such costs. All other charges such as duty, insurance and taxes and other related expenses shall unless otherwise agreed in writing) be paid by the Customer.

5.3. Should the Customer fail to pay any amount when due to PLASSON, the Customer shall be liable to pay to PLASSON without demand interest thereon at the rate of 1% above the rate charged on commercial overdraft accounts in excess of \$100,000.00 applicable from time to time and above by PLASSON's bankers as nominated by PLASSON at the relevant time. Interest payable hereunder shall be compounded monthly and calculated from the due date for payment to the date upon which payment is actually made.

5.4. Notwithstanding anything else appearing in the Agreement, all Charges shall immediately become due if the Customer

shall fail to make any payment when due or shall become subject to the bankruptcy laws or enter into any composition with its creditors or enter into any liquidation or suffer a receiver or receiver and manager to be appointed for all or part of its assets.

5.5. Where payment of the Charges or part of the Charges is due prior to delivery of the Goods and where the Customer fails to make such payment, PLASSON may withhold delivery and give the customer a notice requiring payment to be made within seven days. Should the Customer fail to make the payment which is due within the time required by the notice, PLASSON may terminate the Agreement.

6. PROPERTY OF GOODS PURCHASED

6.1. No legal or equitable title to the Goods shall pass to the Customer until payment in full has been made by the Customer not only of all Charges for all Goods the subject of the Agreement (unless waived in writing by PLASSON) but also until payment has been made of all Charges for all goods previously supplied by PLASSON to the Customer.

6.2. Until the legal and equitable title to the Goods passes to the Customer, the Customer shall:

- (a) Hold the Goods as bailee of PLASSON returnable at will and without prior demand by PLASSON;
- (b) Store the Goods in such a manner as enables them to be readily identified and distinguished from all other goods held by the Customer and, where such other goods include goods previously supplied by PLASSON to the Customer and in respect of which title has passed to the Customer, then the Customer shall attach to the Goods in respect of which title has not passed a notice indication that the Goods are held as bailee for PLASSON;
- (c) Upon demand by PLASSON immediately deliver up the goods to PLASSON; and
- (d) Authorise and the Customer does here by authorise PLASSON to enter upon the premises upon which the Goods are stored for the purpose of taking possession of them.

7. SERVICE

Some Goods may require recalibration annually or at other periods nominated by PLASSON. The Customer may at its own cost transport and deliver the Goods to and from PLASSON's nominated premises from time to time. On receipt of the Goods, PLASSON agrees to recalibrate the Goods (if necessary) provided that the Customer pays PLASSON its then current service charges in respect of such recalibration.

8. INTELLECTUAL PROPERTY LICENCE

PLASSON hereby grants to the Customer a nonexclusive licence to use any software or firmware used in connection with the Goods and supplied by PLASSON. The licence shall be subject to any terms and conditions imposed by PLASSON or the owner of copyright in the software or firmware.

9. FINANCIER

9.1. If PLASSON sells the Goods to a third-party financier (the "Financier") at the request of the Customer, then PLASSON agrees to grant the licence referred to in Clause 8 to the Customer.

9.2. The Customer represents and warrants to PLASSON that if PLASSON sells the Goods to a Financier at the request of the Customer, the Customer shall continue to be bound by all of the terms of the Agreement as if the Customer continued to be the legal and equitable owner of the Goods.

10. DELIVERY AND RISK

10.1. The Goods are sold on an Ex Works basis: delivery of the Goods will occur when the Goods are placed at the disposal of the Customer at PLASSON's premises and risk of loss or damage to the Goods then passes to the Customer. In these circumstances, PLASSON may agree to arrange carriage of the Goods for the Customer but will do so as the agent for the Customer and delivery will occur and risk will pass when the Goods are placed at the disposal of the carrier. The Customer shall pay to PLASSON its Charges for carriage incurred upon the Customer's behalf.

10.2. Delivery dates represent only an estimation of the date of delivery of the Goods and are not binding on PLASSON. Nothing in the Confirmation of Order shall be construed as making time of the essence in the Agreement unless it is expressly stated to be so.

10.3. PLASSON reserves the right to deliver the Goods by instalments and to invoice the Customer for each instalment of Goods delivered where, in the opinion of PLASSON, it is reasonable to do so.

10.4. Failure by the Customer to pay for any instalments, or any other amounts when due, shall entitle PLASSON to withhold or delay delivery of any remaining Goods.

10.5. If PLASSON determines that it is or may be unable to deliver the Goods within a reasonable time or at all, PLASSON may at its sole discretion terminate the Agreement. In the event of termination the Customer shall have no claim against PLASSON for any damage, loss or expense whatsoever.

10.6. If PLASSON is unable to effect delivery, PLASSON may store the Goods and charge the Customer for all costs and expenses associated with such storage and delayed delivery.

10.7. Subject to any express warranty provided in writing by PLASSON to the Customer, failure by the Customer to notify PLASSON within seven days of delivery that the Goods are not in accordance with their description in the Confirmation of Order shall constitute an unqualified acceptance of the Goods and a waiver by the Customer of all claims with respect to the Goods.

If at any point the Customer not completely satisfied with Goods, it is necessary for the Customer to bring this to PLASSON'S attention immediately by contacting PLASSON using the following details:

Attn.: Nelli Sullivan
 Plasson Australia Pty Ltd ACN 053 788 891
 Suite 2.03 Green Central, 61 Dunning Avenue, Rosebery NSW 2018
 NSullivan@plasson.com.au

- 10.8.** In arranging carriage, storage, insurance and forwarding of the Goods PLASSON shall at all times be acting as the Customer's agent and all Charges in relation to same shall be reimbursed by the Customer. This clause shall also apply to any partial delivery of the Goods.
- 10.9.** Any Goods returned to PLASSON by the Customer other than Goods incorrectly supplied, or Goods with major defects will only be accepted by PLASSON on condition that:
- (i) a re-stocking fee of 25% of the Charges applicable to the Goods plus GST and return freight charges are paid by the Customer to PLASSON; and
 - (ii) delivery by the Customer of a Return Authority from PLASSON; and
 - (iii) the Goods are of merchantable quality.

11. IMPLIED TERMS AND LIMITATION OF LIABILITY

- 11.1.** Where conditions, warranties or other rights for the benefit of the Customer are implied or given in respect of the Agreement by Competition and Consumer Act, 2010 and / or the Sales of Goods Act 1896 (as amended) or other laws and it is not lawful or possible to exclude the same, then such conditions, warranties or other rights shall (but only to the extent required by law) apply to the Agreement.
- 11.2.** PLASSON'S Goods come with guarantees that cannot be excluded under the Australian Consumer Law. The Customer is entitled to a replacement or refund for a major failure and compensation for any other reasonably foreseeable loss or damage. The Customer is also entitled to have the Goods repaired or replaced if the Goods fail to be of acceptable quality and the failure does not amount to a major failure.
- 11.3.** To the extent permitted by law and the Goods are not of a kind ordinarily acquired for household use or consumption, liability of PLASSON for breach of this contract by PLASSON or negligence of PLASSON or for breach of any conditions or warranty implied by the Competition and Consumer Act, 2010 and / or the Sales of Goods Act 1896 (as amended) shall be limited to one of the following at PLASSON's option:
- (a) the replacement of the Goods or the supply of equivalent Goods; or
 - (b) the repair of the Goods; or
 - (c) the payment of the costs of replacing the Goods or of acquiring equivalent Goods;
 - (d) the payment of the cost of having the Goods repaired; and in the case of services supplied to one of the following (as PLASSON may determine): (1) the supplying of the services again, or (2) the payment of the costs of having the services supplied again.
- 11.4.** Save as expressly provided in any written warranty provided in writing by PLASSON to the Customer and in and to the extent permitted by law and not withstanding any implication arising from any other clauses in the Agreement, for Goods that are not of a kind ordinarily acquired for household use or consumption PLASSON shall not be liable to the Customer or any person claiming under it in contract or in tort for, or in respect of, any indirect or consequential loss, damage, expense or injury suffered by the Customer or any other person whatsoever, arising out of, in connection with or relating to the performance, non-performance or any breach of the Agreement (including, by way of illustration and not in limitation, liability due to the negligence or wilful default of PLASSON) or any matter relating to the Agreement or any error (whether negligent or not) in information supplied to the Customer before or after the date of the Agreement in connection with its subject matter. "Consequential loss" shall include but not be limited to loss of profit, use or good will (or similar financial loss), payment made or due to any other person and any loss or damage caused by delay in the performance of any obligation, together with any expenses incurred by the Customer in connection therewith, arising therefrom or incurred in mitigation or attempted mitigation of such loss or damage.
- 11.5.** Clause 11.4 shall apply to all express warranties provided in writing by PLASSON except to the extent that those warranties specifically provide otherwise.
- 11.6.** Where any law implies into the Agreement a condition that the Goods are of merchantable quality, and the Goods are purchased by the Customer for particular purpose, the Goods will not be considered by the Customer as being fit for any other purpose, whether or not that other purpose is one for which goods of that kind are commonly bought.

12. DEPOSIT

- 12.1.** Where PLASSON agrees to supply Goods upon the condition that a deposit of part or all of the charges is paid prior to delivery ("the Deposit"), in the event that the Customer terminates the Agreement or fails to take delivery of the Goods or is otherwise in breach of its obligations to PLASSON so that PLASSON is entitled to terminate the Agreement, the Customer shall forfeit ten per cent of the Deposit to PLASSON for PLASSON's benefit and PLASSON shall refund the balance to the Customer.
- 12.2.** The forfeiture of the Deposit shall not be deemed any limitation, in damages or otherwise including damages for loss of profits, of the liability of the Customer to PLASSON.

13. TERMINATION

- In addition to the rights of termination provided in the above conditions, PLASSON may terminate the Agreement upon the occurrence of any of the following events:
- (a) Failure by the Customer to perform any obligation of this Agreement where such failure is not rectified within 30 days of notice from PLASSON requesting rectification.
 - (b) The Customer becomes bankrupt or an order is made or a resolution is passed for the winding up of the Customer or a ground arises on which a court may order its winding up or upon which a meeting may rely for the purposes of placing the Customer under official management or an inspector is appointed to investigate its affairs or it proposes to or enters into any arrangement, scheme, reconstruction or composition with creditors.
 - (c) A receiver of receiver and manager of the Customer's assets, income or business or any part thereof is appointed, or a mortgagee goes into possession thereof and such appointment is not terminated, or such possession does not cease within fourteen days.
 - (d) The Customer shall fail to pay its debts as they shall fall due or cease or threaten to cease to carry on business or sell, assign, transfer the whole or any part of its undertaking or assets otherwise than in the ordinary course of business.

- (e) The Customer purports to assign its rights under the Agreement.
- (f) Any event occurs outside the reasonable control of PLASSON which in PLASSON's estimate makes it impracticable or impossible to for it to fulfil its obligation under the Agreement.

14. FORCE MAJEURE

- 14.1.** PLASSON will not be liable for any loss or damage suffered by the Customer due to any delay or any breach or default under the Agreement in circumstances where such delay, breach or default results from causes beyond PLASSON's reasonable control including but not limited to any breach or default under the Agreement by the Customer, compliance with any laws, regulations, orders, acts, instructions or priority requests of governments, acts of God, fires, floods, weather, strikes, lockouts, factory shutdown or alterations, embargoes, wares, riots, delay or shortage in transportation or inability to obtain labour, manufacturing facilities, electricity, oil or other materials from PLASSON's or the Manufacturer's usual sources.
- 14.2.** Any delay resulting from such cause shall immediately extend the delivery date by the period of delay in which event the Customer shall take, if necessary, steps to secure payment for the Goods.

15. MISCELLANEOUS

- 15.1** Any indulgence, latitude or extension of time which PLASSON may show towards the Customer in relation to any of the provisions of the Agreement or any matter or thing relating thereto or arising therefrom shall not in any way prejudice or interfere with PLASSON's rights under the Agreement and shall not be claimed to constitute a waiver thereof.
- 15.2** The Customer acknowledges that no oral terms or representations form part of the Agreement unless they have been reduced to writing and signed by PLASSON prior to entering into the Agreement.
- 15.3** Any notice to be given to a party shall be in writing and shall be sent by post, email or facsimile to the address of that party as shown in the Confirmation of Order or as subsequently notified by that party to the party giving the notice and shall be deemed to have been given:
- (a) in the case of post, 5 Business Days after the date of posting (or 10 Business Days in the event that the Customer is located outside of Australia;
 - (b) in case of email, on the day and at the time the email is sent unless a delivery failure notification is received by the sender within 4 hours of sending the email; and
 - (c) in the case of hand delivery, when delivered.
- 15.4** The Agreement shall be governed by the laws of New South Wales and the parties agree to submit to the jurisdiction of the Courts for that State.
- 15.5** In the event of PLASSON seeking to recover any amount due from the Customer or to enforce any of its other rights under the Agreement, the Customer undertakes to pay to PLASSON any costs incurred by PLASSON in so doing, including any legal costs incurred on the solicitor and own client basis.

16. SECURITY INTEREST

- (a) The Customer hereby acknowledges that these terms and conditions of sale constitute a security agreement which creates a Security Interest in favour of PLASSON in all present and after acquired property of the Customer including Goods supplied by PLASSON to the Customer and all after acquired Goods supplied to the Customer by PLASSON (or for the Customer's account) to secure the payment from time to time for Goods, including future advances.
- (b) The Customer agrees to grant to PLASSON:
 - (i) a Purchase Money Security Interest in relation to any Goods supplied by PLASSON to the Customer; and
 - (ii) a Security Interest in all of its present and after acquired property in which Goods supplied or financed by PLASSON have been attached or incorporated, including any Commingled Goods and in any proceeds of sale of Goods.

17. GENERAL COVENANTS

- (a) Until such time as payment in full has been received by PLASSON from the Customer in respect to an Order, the Customer covenants to PLASSON not to create, cause or permit to exist any other Security Interest over any Goods the subject of the applicable Order, other than a Permitted Security Interest and covenants that it shall comply with the terms of each Permitted Security Interest binding on it in respect of the relevant Goods from time to time and shall ensure that:
 - (i) there is no increase in the amount secured under a Permitted Security Interest (excluding any part of a Permitted Security Interest which is a purchase money security interest); and (ii) there is no variation to a Permitted Security Interest that increases the collateral the subject of the Permitted Security Interest, other than in the case of a purchase money security interest, without obtaining the prior written consent of PLASSON.
- (b) The Customer covenants to PLASSON that it shall sign anything and do anything PLASSON requires to further or more effectively secure PLASSON's rights over the applicable Goods or under these terms and conditions. This includes anything PLASSON requires in order for it to: (i) register and maintain (including renew before expiry) one or more financing statements in relation to any Security Interest in the relevant Goods created by these terms and conditions and/or any Order;
 - (ii) remove any financing statement which is registered against the Customer or in relation to a Security Interest which is not a Permitted Security Interest; and (iii) obtain possession or control of any Goods for the purposes of perfecting any Security Interest in that property by possession or control for the purposes of the PPSA.
- (c) The Customer waives its rights to receive a verification statement in respect of any financing statement or financing change statement registered by or on behalf of PLASSON under the PPSA to the extent permitted by the PPSA and agrees to that as between PLASSON and the Customer will have no rights under (or by reference to) sections 95, 96, 117, 118, 120, 121(4), 123, 125, 126, 128, 129, 130, 132(3)(d), 132(4), 134(1), 135, 142 and 143 of the PPSA.



 **PLASSON**[®]
AUSTRALIA

PLASSON AUSTRALIA

plasson.com.au

1300 752 776

sales@plasson.com.au

ABN 40 053 788 891